

USER'S GUIDE
Agilent Technologies
Model N3280A
Component Test DC Source



Agilent Technologies

Agilent Part No. 5964-8248
Microfiche No. 5964-8249

Warranty Information

CERTIFICATION

Agilent Technologies certifies that this product met its published specifications at time of shipment from the factory. Agilent Technologies further certifies that its calibration measurements are traceable to the United States National Bureau of Standards, to the extent allowed by the Bureau's calibration facility, and to the calibration facilities of other International Standards Organization members.

WARRANTY

This Agilent Technologies hardware product is warranted against defects in material and workmanship for a period of three years from date of delivery. Agilent Technologies software and firmware products, which are designated by Agilent Technologies for use with a hardware product and when properly installed on that hardware product, are warranted not to fail to execute their programming instructions due to defects in material and workmanship for a period of 90 days from date of delivery. During the warranty period Agilent Technologies will, at its option, either repair or replace products which prove to be defective. Agilent does not warrant that the operation for the software firmware, or hardware shall be uninterrupted or error free.

For warranty service, with the exception of warranty options, this product must be returned to a service facility designated by Agilent Technologies. Customer shall prepay shipping charges by (and shall pay all duty and taxes) for products returned to Agilent Technologies for warranty service. Except for products returned to Customer from another country, Agilent Technologies shall pay for return of products to Customer.

Warranty services outside the country of initial purchase are included in Agilent Technologies' product price, only if Customer pays Agilent Technologies international prices (defined as destination local currency price, or U.S. or Geneva Export price).

If Agilent is unable, within a reasonable time to repair or replace any product to condition as warranted, the Customer shall be entitled to a refund of the purchase price upon return of the product to Agilent Technologies.

LIMITATION OF WARRANTY

The foregoing warranty shall not apply to defects resulting from improper or inadequate maintenance by the Customer, Customer-supplied software or interfacing, unauthorized modification or misuse, operation outside of the environmental specifications for the product, or improper site preparation and maintenance. NO OTHER WARRANTY IS EXPRESSED OR IMPLIED. AGILENT TECHNOLOGIES SPECIFICALLY DISCLAIMS THE IMPLIED WARRANTIES OF MERCHANTABILITY AND FITNESS FOR A PARTICULAR PURPOSE.

EXCLUSIVE REMEDIES

THE REMEDIES PROVIDED HEREIN ARE THE CUSTOMER'S SOLE AND EXCLUSIVE REMEDIES. AGILENT TECHNOLOGIES SHALL NOT BE LIABLE FOR ANY DIRECT, INDIRECT, SPECIAL, INCIDENTAL, OR CONSEQUENTIAL DAMAGES, WHETHER BASED ON CONTRACT, TORT, OR ANY OTHER LEGAL THEORY.

ASSISTANCE

The above statements apply only to the standard product warranty. Warranty options, extended support contacts, product maintenance agreements and customer assistance agreements are also available. Contact your nearest Agilent Technologies Sales and Service office for further information on Agilent Technologies' full line of Support Programs.

Safety Summary

The following general safety precautions must be observed during all phases of operation of this instrument. Failure to comply with these precautions or with specific warnings elsewhere in this manual violates safety standards of design, manufacture, and intended use of the instrument. Agilent Technologies assumes no liability for the customer's failure to comply with these requirements.

GENERAL

This product is a Safety Class 1 instrument (provided with a protective earth terminal). The protective features of this product may be impaired if it is used in a manner not specified in the operation instructions. Any LEDs used in this product are Class 1 LEDs as per IEC 825-1.

ENVIRONMENTAL CONDITIONS

This instrument is intended for indoor use in an installation category II, pollution degree 2 environment. It is designed to operate at a maximum relative humidity of 95% and at altitudes of up to 4500 meters. Refer to the specifications tables for the ac mains voltage requirements and ambient operating temperature range.

BEFORE APPLYING POWER

Verify that the product is set to match the available line voltage, the correct fuse is installed, and all safety precautions are taken. Note the instrument's external markings described under "Safety Symbols".

GROUND THE INSTRUMENT

To minimize shock hazard, the instrument chassis and cover must be connected to an electrical ground. The instrument must be connected to the ac power mains through a grounded power cable, with the ground wire firmly connected to an electrical ground (safety ground) at the power outlet. Any interruption of the protective (grounding) conductor or disconnection of the protective earth terminal will cause a potential shock hazard that could result in personal injury.

ATTENTION: Un circuit de terre continu est essentiel en vue du fonctionnement sécuritaire de l'appareil. Ne jamais mettre l'appareil en marche lorsque le conducteur de mise ... la terre est d,branch,.

FUSES

Only fuses with the required rated current, voltage, and specified type (normal blow, time delay, etc.) should be used. Do not use repaired fuses or short-circuited fuseholders. To do so could cause a shock or fire hazard.

Vous devrez impérativement utiliser des fusibles calibrés aux spécifications de courant, tension et type (coupure, délai de coupure, etc ...). N'utilisez jamais de fusibles réparés et ne court-circuitiez pas les supports de fusibles. Sinon, vous risquez de provoquer un choc électrique ou un incendie.

DO NOT OPERATE IN AN EXPLOSIVE ATMOSPHERE

Do not operate the instrument in the presence of flammable gases or fumes.

DO NOT REMOVE THE INSTRUMENT COVER

Operating personnel must not remove instrument covers. Component replacement and internal adjustments must be made only by qualified service personnel.

Instruments that appear damaged or defective should be made inoperative and secured against unintended operation until they can be repaired by qualified service personnel.

SAFETY SYMBOLS



Direct current



Alternating current



Both direct and alternating current



Three-phase alternating current



Earth (ground) terminal



Protective earth (ground) terminal



Frame or chassis terminal



Terminal is at earth potential. Used for measurement and control circuits designed to be operated with one terminal at earth potential.



Terminal for Neutral conductor on permanently installed equipment



Terminal for Line conductor on permanently installed equipment



On (supply)



Off (supply)



Standby (supply). Units with this symbol are not completely disconnected from ac mains when this switch is off. To completely disconnect the unit from ac mains, either disconnect the power cord or have a qualified electrician install an external switch.



In position of a bi-stable push control



Out position of a bi-stable push control



Caution, risk of electric shock



Caution, hot surface



Caution (refer to accompanying documents)

WARNING

The WARNING sign denotes a hazard. It calls attention to a procedure, practice, or the like, which, if not correctly performed or adhered to, could result in personal injury. Do not proceed beyond a WARNING sign until the indicated conditions are fully understood and met.

Caution

The CAUTION sign denotes a hazard. It calls attention to an operating procedure, or the like, which, if not correctly performed or adhered to, could result in damage to or destruction of part or all of the product. Do not proceed beyond a CAUTION sign until the indicated conditions are fully understood and met.

Declaration Page

Acoustic Noise Information

Herstellerbescheinigung

Diese Information steht im Zusammenhang mit den Anforderungen der Maschinenläminformationsverordnung vom 18 Januar 1991.

- * Schalldruckpegel $L_p < 70$ dB(A)
- * Am Arbeitsplatz
- * Normaler Betrieb
- * Nach EN 27779 (Typprüfung).

Manufacturer's Declaration

This statement is provided to comply with the requirements of the German Sound Emission Directive, from 18 January 1991.

- * Sound Pressure $L_p < 70$ dB(A)
- * At Operator Position
- * Normal Operation
- * According to EN 27779 (Type Test).

Printing History

The edition and current revision of this manual are indicated below. Reprints of this manual containing minor corrections and updates may have the same printing date. Revised editions are identified by a new printing date. A revised edition incorporates all new or corrected material since the previous printing date.

Changes to the manual occurring between revisions are covered by change sheets shipped with the manual. In some cases, the manual change applies only to specific instruments. Instructions provided on the change sheet will indicate if a particular change applies only to certain instruments.

This document contains proprietary information protected by copyright. All rights are reserved. No part of this document may be photocopied, reproduced, or translated into another language without the prior consent of Agilent Technologies. The information contained in this document is subject to change without notice.

Table of Contents

Warranty Information	2
Safety Summary	3
Declaration Page	5
Acoustic Noise Information	6
Printing History	6
Table of Contents	7
1 - GENERAL INFORMATION	13
Document Orientation	13
Safety Considerations	13
Options and Accessories	14
Description	14
Remote Programming	14
Output Characteristics	15
Voltage Priority Operation	15
Current Priority Operation	16
Measurement Characteristics	17
Start of a Measurement	18
2 - INSTALLATION	19
Inspection	19
Damage	19
Packaging Material	19
Additional Items	19
Cleaning	19
Location	20
Bench Operation	20
Rack Mounting	20
Power Connections	21
Connect the Power Cord	21
Output Connections	22
Outputs 1 - 4	22
Current Ratings	23
Voltage Drops and Lead Resistance	23
Coaxial Guard Connections	24
Maintaining Stability	25
OVP Considerations	25
External Trigger Connections	25
Computer Connections	25
GPIB Interface	25
GPIB Address	26
3 - TURN-ON CHECKOUT	27
Front Panel Description	27
Checkout Procedure	28
In Case of Trouble	29
Selftest Error Messages	29
Runtime Error Messages	29
Line Fuse	29
4 - INTRODUCTION TO PROGRAMMING	31
External References	31
GPIB References	31

SCPI References	31
 GPIB Capabilities of the DC Source	31
 Introduction to SCPI	32
Conventions Used in This Guide	32
 Types of SCPI Commands	32
Multiple Commands in a Message	33
Moving Among Subsystems	33
Including Common Commands	33
Using Queries	33
 Types of SCPI Messages	34
The Message Unit	34
Channel Parameter	34
Headers	34
Query Indicator	35
Message Unit Separator	35
Root Specifier	35
Message Terminator	35
 SCPI Data Formats	35
Numerical Data Formats	35
Suffixes and Multipliers	36
Response Data Types	36
 SCPI Command Completion	36
 Using Device Clear	37
5 - PROGRAMMING THE DC SOURCE	39
 Introduction	39
 Programming the Output	39
Power-on Initialization	39
Enabling the Output	39
Output Voltage	39
Overvoltage Protection	40
Output Current	40
Output Mode	40
Oscillation Protection	41
 Triggering Output Changes	41
Output Trigger Model	41
Setting the Voltage and Current Trigger Levels	42
Enabling the Output Trigger System	42
Selecting the Output Trigger Source	42
Generating Output Triggers	43
 Making Measurements	43
Average Measurements	43
Power Line Cycles	44
Measurement Samples and Time Interval	44
Current Ranges	45
Window Functions	45
Returning All Measurement Data From the Data Buffer	45
 Triggered Measurements	45
Measurement Trigger Model	46
Enabling the Measurement Trigger System	46
Selecting the Measurement Trigger Source	46
Selecting the Sensing Function	47
Output Settling Delay	47
Generating Measurement Triggers	47
Pre-trigger and Post-trigger Data Acquisition	48
 Programming the Status Registers	49
Operation Status Group	50

Questionable Status Group	51
Standard Event Status Group	51
Status Byte Register	51
Determining the Cause of a Service Interrupt	52
Servicing Operation Status and Questionable Status Events	52
6 - LANGUAGE DICTIONARY	53
Introduction	53
Subsystem Commands	53
Common Commands	53
Programming Parameters	53
SCPI Programming Commands - At a Glance	54
Calibration Commands	57
CALibrate:CURRent	57
CALibrate:CURRent:LIMit[:POSitive] CALibrate:CURRent:LIMit:NEGative	57
CALibrate:CURRent:MEASure	57
CALibrate:DATA	58
CALibrate:DATE	58
CALibrate:LEVel	58
CALibrate:PASSword	58
CALibrate:SAVE	59
CALibrate:STATe	59
CALibrate:VOLTage	59
Measurement Commands	60
FETCh:ARRay:CURRent? FETCh:ARRay:VOLTage?	60
FETCh:CURRent? FETCh:VOLTage?	60
MEASure:ARRay:CURRent? MEASure:ARRay:VOLTage?	61
MEASure:CURRent? MEASure:VOLTage?	61
SENSe:CURRent:RANGe	61
SENSe:FUNCTion	62
SENSe:SWEEp:NPLCycles	62
SENSe:SWEEp:OFFSet:POINts	62
SENSe:SWEEp:POINts	63
SENSe:SWEEp:TINTerval	63
SENSe:WINDow	63
Output Commands	64
OUTPut	64
OUTPut:OSCProtect	64
OUTPut:PROTection:CLEar	64
[SOURce:]CURRent[:IMMediate] [SOURce:]CURRent:TRIGgered	65
[SOURce:]CURRent:LIMit[:IMMediate] [SOURce:]CURRent:LIMit:TRIGgered	65
[SOURce:]CURRent:MODE [SOURce:]CURRent:LIMit:MODE	65
[SOURce:]DELay	66
[SOURce:]DELay:MODE	66
[SOURce:]FUNCTion:MODE	66
[SOURce:]VOLTage:ALC:BWIDth	66
[SOURce:]VOLTage[:IMMediate] [SOURce:]VOLTage:TRIGgered	67
[SOURce:]VOLTage:MODE	67
[SOURce:]VOLTage:PROTection:STATe	67
Status Commands	68
STATus:OPERation[:EVENT]?	68
STATus:OPERation:CONDition?	68
STATus:OPERation:ENABle	68
STATus:OPERation:NTR STATus:OPERation:PTR	69
STATus:PRESet	69
STATus:QUEStionable[:EVENT]?	69
STATus:QUEStionable:CONDition?	70

STATus:QUESTionable:ENABLE	70
STATus:QUESTionable:NTR STATus:QUESTionable:PTR	70
System Commands	71
SYSTem:ERRor?	71
SYSTem:VERSion?	71
Trigger Commands	72
ABORt	72
INITiate:NAME	72
TRIGger:ACQuire	72
TRIGger:ACQuire:SOURce	73
TRIGger[:TRANsient]:SOURce	73
TRIGger[:TRANsient]	73
Common Commands	74
*CLS	74
*ESE	74
*ESR?	74
*IDN?	75
*OPC	75
*OPT?	75
*RST	76
*SRE	76
*STB?	76
*TRG	77
*TST?	77
*WAI	77
A - SPECIFICATIONS	79
Introduction	79
B - PERFORMANCE TESTS AND CALIBRATION	83
Introduction	83
Equipment Required	83
Performance & Verification Tests	84
Measurement Techniques	84
Electronic Load	84
Programming	85
Test Setup	85
Voltage Priority Tests	86
Voltage Programming and Readback Accuracy	86
Positive Current Limit (+CL)	86
Negative Current Limit (-CL)	87
Current Priority Tests	88
Current Programming and Readback Accuracy	88
Load Effect Tests	89
Voltage Priority, Constant Voltage Load Effect	89
Voltage Priority, +Current Limit Load Effect	90
Voltage Priority, -Current Limit Load Effect Test	90
Current Priority Constant Current Test	91
Source Effect Tests	91
Voltage Priority, Constant Voltage Source Effect	91
Voltage Priority, +Current Limit Source Effect	92
Voltage Priority, -Current Limit Source Effect	92
Current Priority, Constant Current Source Effect	93
Ripple and Noise Tests	94
Voltage Priority Ripple and Noise	94
Current Priority Ripple and Noise	94

Transient Response Tests	95
Voltage Priority, Transient Recovery Time	95
Current Priority Transient Recovery Time	96
Performance Test Equipment Form	97
Performance Test Record Form	98
Performing the Calibration Procedure	99
Enable Calibration Mode	99
Voltage Priority Mode Programming and Measurement Calibration	99
Negative Current Limit Calibration	100
Positive Current Limit Calibration	100
0.5A Range Current Measurement Calibration	100
15mA Range Current Measurement Calibration	101
Current Priority Mode Programming and 0.5mA Range Measurement Calibration	101
Saving the Calibration Constants	101
Changing the Calibration Password	102
Calibration Error Messages	102
C - ERROR MESSAGES	103
Error Number List	103
D - LINE VOLTAGE SELECTION	107
INDEX	109

General Information

Document Orientation

This manual describes the operation of the Agilent Model N3280A Component Test DC Source. Unless otherwise noted, the unit will be referred to by the description "dc source" throughout this manual.

The following Getting Started Map is a general guide to the location of information in this manual. Refer to the table of contents or index for a complete list of information.

Getting Started Map

Task	Where to find information
General information Capabilities and characteristics	Chapter 1
Installing the unit Line connections Load connections Computer connections	Chapter 2
Checking out the unit Verifying proper operation	Chapter 3
Using the programming interface GPIB interface	Chapter 4
Programming the unit using SCPI commands SCPI commands SCPI programming examples SCPI language dictionary	Chapters 5 and 6
Specifications	Appendix A
Verifying and Calibrating the Unit	Appendix B

Safety Considerations

This dc source is a Safety Class 1 instrument, which means it has a protective earth terminal. That terminal must be connected to earth ground through a power source equipped with a ground receptacle. Refer to the Safety Summary page at the beginning of this guide for general safety information. Before installation or operation, check the dc source and review this guide for safety warnings and instructions. Safety warnings for specific procedures are located at appropriate places in the guide.

Options and Accessories

Table 1-1. Options

Option	Description
100	87–106 Vac, 47–63 Hz
220	191–233 Vac, 47–63 Hz
230	207–253 Vac, 47–63 Hz
8ZL	Add instrument feet - for bench mounting (p/n 5041-9167)
AXS ¹	Rack mount kit for two side-by-side N3280A units. Consists of: Lock-link kit (p/n 5061-9694), Flange kit (p/n 5063-9212), Tie bracket (p/n 5002-1587)
1CM ¹	Rack mount kit for one unit (p/n 5063-9240)

¹Support rails are required when rack mounting units. Use E3663A support rails for Agilent rack cabinets. If you are using non-Agilent rack cabinets, contact the rack manufacturer to obtain support rails for your cabinet.

Table 1-2. Accessories

Item	Part Number	
GPIB cables	1.0 meter (3.3 ft)	Agilent 10833A
	2.0 meters (6.6 ft)	Agilent 10833B
	4.0 meters (13.2 ft)	Agilent 10833C
	0.5 meters (1.6 ft)	Agilent 10833D
Rack mount with slide - for two side-by-side units	Order 5063-9255 and 1494-0015	
Rack mount with slide - for one unit	Order 5063-9255, 1494-0015, and 5002-3999	

Description

The Agilent Model N3280A Component Test DC Source is a quad output dc power supply designed to simplify the testing of integrated circuits. It has the following key features and performance capabilities:

- ◆ High density – four isolated outputs in a 2U half-rack package
- ◆ Four quadrant bipolar output
- ◆ High programming and measurement accuracy (refer to Appendix A)
- ◆ Active guard available for accurate current measurements
- ◆ Solid-state output and sense terminal disconnect relays
- ◆ High GPIB throughput

Additional features include:

- ◆ Positive and negative overvoltage protection shutdown
- ◆ Over-temperature and oscillation protection
- ◆ Programmable current limit in voltage priority mode

Remote Programming

NOTE: With the exception of the power switch, there are no front panel controls for the Agilent N3280A dc source. The N3280A can be controlled only with SCPI programming commands.

The dc source may be remotely programmed via the GPIB bus. GPIB programming is with SCPI commands (Standard Commands for Programmable Instruments), which make dc source programs compatible with those of other GPIB instruments. Dc source status registers allow remote monitoring of a wide variety of operating conditions. Refer to chapters 5 and 6 for more information.

Output Characteristics

Voltage Priority Operation

Each Agilent N3280A output is a four-quadrant bipolar dc source that can be operated in either voltage or current priority mode. In voltage priority mode the output is controlled by a bi-polar constant voltage feedback loop, which maintains the output voltage at its positive or negative programmed setting. The output voltage will remain at its programmed setting as long as the load current remains within the positive or negative current limit. A single positive value programs both the positive and negative current limit.

Figure 1-1 shows the voltage priority operating characteristics of the dc source. The area in quadrants 1 and 3 shows the characteristics of the output when it is being operated as a source (sourcing power). The area in quadrants 2 and 4 shows the characteristics of the output when it is being operated as a load (sinking power).

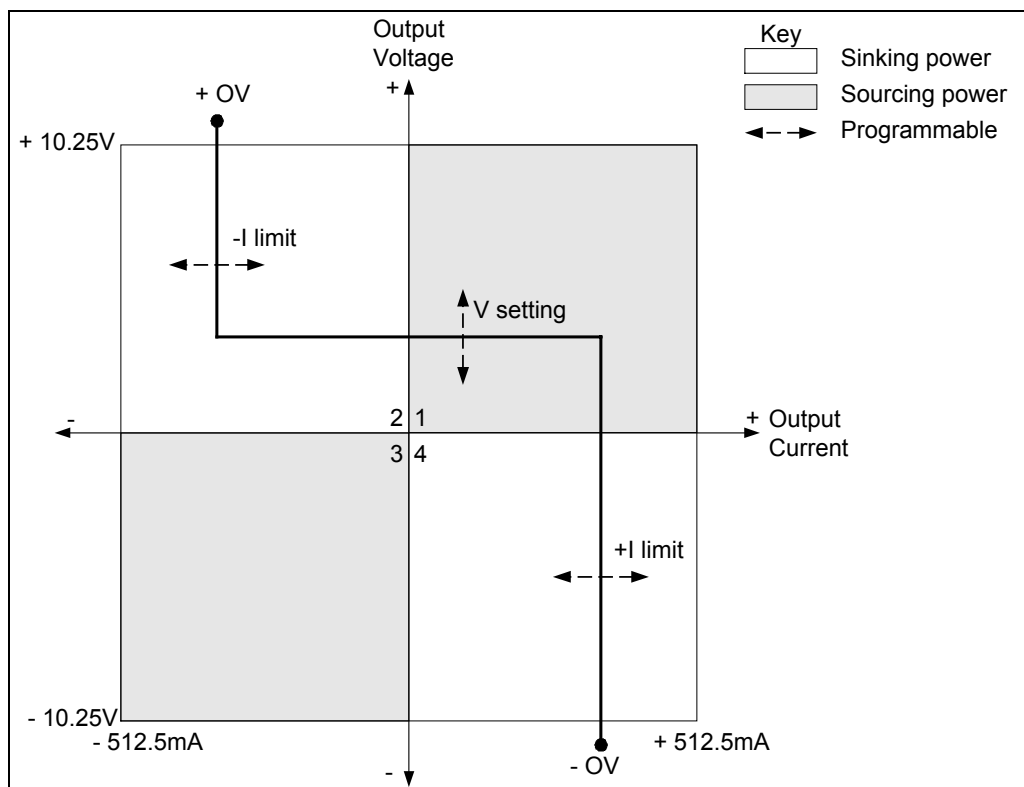

Figure 1-1. Output Characteristic (Voltage Priority)

The heavy line illustrates the locus of possible operating points as a function of the output load, which may be purely resistive, or possibly include external voltage or current sources. In voltage priority mode, the constant voltage loop will regulate the output voltage as the load changes, unless the output current attempts to exceed the current limit setting.

If this occurs, either the negative or the positive current limit loop will regulate the output current at the programmed value. Either a CV (constant voltage), CL+ (positive current limit), or CL- (negative current limit) status flag is set to indicate which loop is presently controlling the output.

1 - General Information

If the output voltage exceeds either the positive or negative overvoltage set point, the output will shut down and be disabled, automatically opening the output and sense relays. This leaves the output in a high-impedance state.

The full ± 512.5 milliampere output current is available only in voltage priority mode. In this mode, the output voltage should be programmed to the desired positive or negative value. A positive current limit value should also be programmed. Note that the negative current limit tracks the positive current limit set point. The output will regulate at the desired voltage level, provided that the current limit has been set higher than the actual output current requirement of the external load. Note that if the current limit is set to a value between zero and $75 \mu\text{A}$, the actual current limit will be $\pm 75 \mu\text{A}$. Thus, it is not possible to program current limit values less than $75 \mu\text{A}$ in voltage priority mode. (This limitation does not apply in current priority mode.)

Current Priority Operation

Each Agilent N3280A output is a four-quadrant bipolar dc source that can be operated in either voltage or current priority mode. In current priority mode the output is controlled by a bi-polar constant current feedback loop, which maintains the output current (source or sink) at its programmed setting. The output current will remain at its programmed setting as long as the load voltage remains within the positive and negative voltage limits. The voltage limits are not programmable and vary somewhat with the output current. When the output current is zero, the voltage limits are typically $\pm 10.75 \text{ V}$.

Figure 1-2 shows the current priority operating characteristics of the dc source. The area in quadrants 1 and 3 shows the characteristics of the unit when it is being operated as a source (sourcing power). The area in quadrants 2 and 4 shows the characteristics of the unit when it is being operated as a load (sinking power).

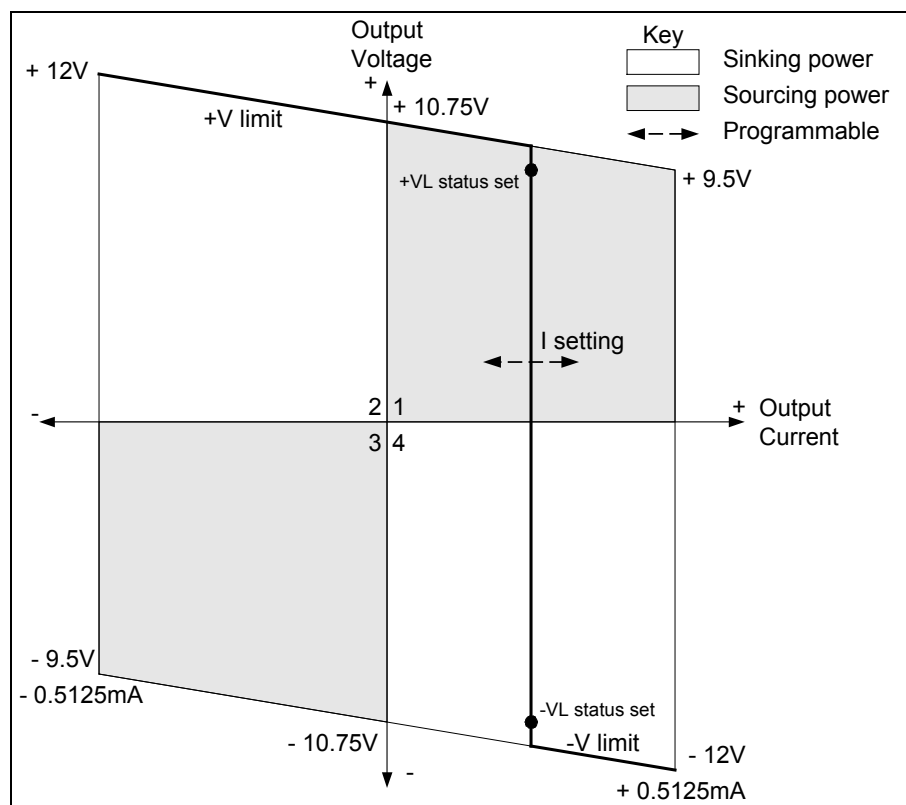

Figure 1-2. Output Characteristic (Current Priority)

The heavy line illustrates the locus of possible operating points as a function of the output load, which may be purely resistive, or possibly include external voltage or current sources. In current priority mode, the constant current loop will regulate the output current as the load changes, until the positive or negative voltage limit is reached. A CC (constant current) status flag indicates when the current loop is controlling the output.

If the output voltage reaches either the positive or negative voltage limit, the unit no longer operates in constant current mode and the output current is no longer held constant. Instead, the output current is limited at either the positive or negative voltage limit line. When the unit is sinking power, the output voltage will continue to increase in the positive or negative direction as more current is forced into the unit. Note that a VL+ (positive voltage limit) or VL- (negative voltage limit) status bit will be set to register a voltage limit at about 0.8 V *before* the positive or negative voltage line is reached.

The maximum current available in current priority mode is about 0.5 mA, which is ideal for testing sensitive devices such as input diodes. In this mode, the output current must be programmed to the desired positive or negative value. However, the positive and negative voltage limits are not programmable, and vary with the actual output current as shown in the figure. The typical positive voltage limit ranges from about 10.75V at no load to about 9.5V at full load. The typical negative voltage limit ranges from about -10.75V to about -9.5V.

NOTE: Overvoltage protection is not functional in current priority mode.

Measurement Characteristics

The N3280A uses a digitizing measurement system with a single timebase for all output channels. The number of measurement samples and the sampling interval of the timebase can be explicitly programmed. These values will apply to measurements taken on all outputs. For example, if simultaneous measurements are made on four output channels and one of the three channels is set to one power line cycle (PLC), then all three channels will be set to one power line cycle per measurement.

Conversely, each output channel of the N3280A has its own measurement buffer. This means that each output can be configured to measure a different parameter (either voltage or current), and a different current range. However, the number of measurement samples and sampling interval for each type of measurement is the same for all channels.

There is one voltage measurement range and three current measurement ranges. The current range must be selected explicitly. If a measured value exceeds the presently selected range, an error message is returned. Voltage measurements and current measurements using the 0.5A or 15mA range can be made to full accuracy using the default measurement sample (5 data points @30.4µs intervals = 152 µs). To achieve full accuracy on the 0.5mA current range, a longer sampling interval of one power line cycle (PLC) is required to filter out line noise. Thus, a full accuracy measurement on the 0.5mA current range will typically take between 18 and 21.3 ms, depending on the line frequency.

Note that faster measurements using lower PLC values (<1) are only appropriate for loads that do not draw currents with a significant noise component. If the load current is noisy, it may be necessary to increase the sampling interval to provide additional filtering.

All voltage and current measurements return the average value of the samples taken. Measurements can be made using either a Rectangular or Hanning window. The default Rectangular window is used on all

1 - General Information

measurement ranges to make fast measurements. The Hanning window can be used to reduce errors caused by other periodic noise sources, provided that the sample period is long enough to capture three or more noise waveform cycles. Using a Hanning window will result in slower measurement speed.

Start of a Measurement

The dc source delays the start of a measurement until a previous output voltage or current change has settled. When voltage or current settings are changed in either voltage priority or in current priority mode, an internal timer is started that delays any subsequent measurements. At power-on or after *RST this delay allows the output to settle to better than 0.1% of its final value. In voltage priority mode, the final value is based on a 20 ohm load. In current priority mode, the final value is based on a short-circuit load.

The settling delay can also be explicitly programmed. This may be required, for example, if the load requires more or less delay than the representative load or if the measurement requires less accuracy.

Installation

Inspection

Damage

When you receive your dc source, inspect it for any obvious damage that may have occurred during shipment. If there is damage, notify the shipping carrier and the nearest Agilent Sales and Support Office immediately. The list of Agilent Sales and Support Offices is at the back of this guide. Warranty information is printed in the front of this guide.

Packaging Material

Until you have checked out the dc source, save the shipping carton and packing materials in case the unit has to be returned. If you return the dc source for service, attach a tag identifying the owner's name and address, the model number, and a brief description of the problem.

Additional Items

Table 2-1. Items Supplied

Item	Part Number	Description
Power Cord	contact the nearest Agilent Sales and Support Office	A power cord appropriate for your location.
Trigger connector	1252-8670	3-terminal digital plug for connecting the trigger input signal. The connector installs in the back of the unit.
Line Fuse	2110-0638 2110-0773	3.15 AT (time delay) for 100/120 Vac operation 1.6 AT (time delay) for 220/230 Vac operation
User's Guide	5964-8248	This manual.

Table 2-2. Items Not Supplied

Feet	5041-9167	Feet for bench mounting
Output connectors (for wires)	CHG-2010-J01010-KEP	10-terminal output plug for connecting load and sense wires. Connector installs in the back of the unit. Can be ordered from 3M company (www.3m.com/interconnects)
Output connectors (with coax)	9821-017- <u>36</u> -AZN (underline specifies coax length)	10-terminal output plug with terminated 36" coaxial cables. Connector installs in the back of the unit. Can be ordered from 3M company (www.3m.com/interconnects)

Cleaning

Use a dry cloth or one slightly dampened with water to clean the external case. Do NOT open the unit.

WARNING: To prevent electric shock, unplug the unit before cleaning.

Location

Figure 2-1 gives the dimensions of your dc source. The dc source must be installed in a location that allows enough space at the sides and back of the unit for adequate air circulation (see Bench Operation).

NOTE: This dc source generates magnetic fields that may affect the operation of other instruments. If your instrument is susceptible to operating magnetic fields, do not locate it in the immediate vicinity of the dc source. Typically, at 5 millimeters from the dc source, the electromagnetic field is less than 5 gauss. Many CRT's, such as those used in computer displays, are susceptible to magnetic fields much lower than 5 gauss. Check susceptibility before mounting any display near the dc source.

Bench Operation

Do not block the fan exhaust at the rear of the unit.

A fan cools the dc source by drawing air in through the sides and exhausting it out the back. Minimum clearances for bench operation are 1 inch (25 mm) along the sides.

Rack Mounting

The dc source can be mounted in a standard 19-inch rack panel or cabinet. Table 1-1 documents the part numbers for the various rack mounting options that are available for the dc source. Installation instructions are included with each rack mount option.

NOTE: Support rails or an instrument shelf is required when rack mounting units.

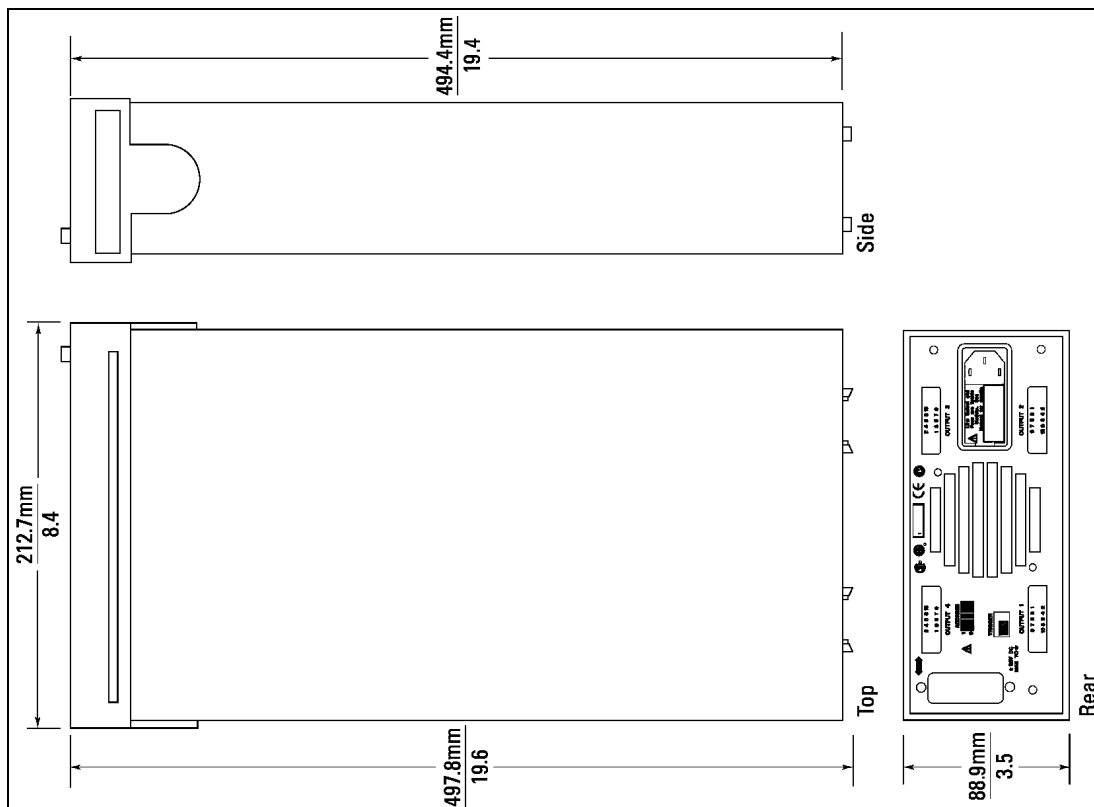

Figure 2-1. Outline Diagram

Power Connections

Connect the Power Cord

Connect the power cord to the IEC 320 connector on the rear of the unit. If the wrong power cord was shipped with your unit, contact your nearest Agilent Sales and Support Office to obtain the correct cord (refer to the list at the back of this guide).

Check the line voltage rating label on the back of the unit to make sure that it agrees with your ac mains voltage. Refer to appendix E if the voltage at your site is different from the voltage indicated on the unit.

Figure 2-2 identifies all rear panel connections on the dc source.

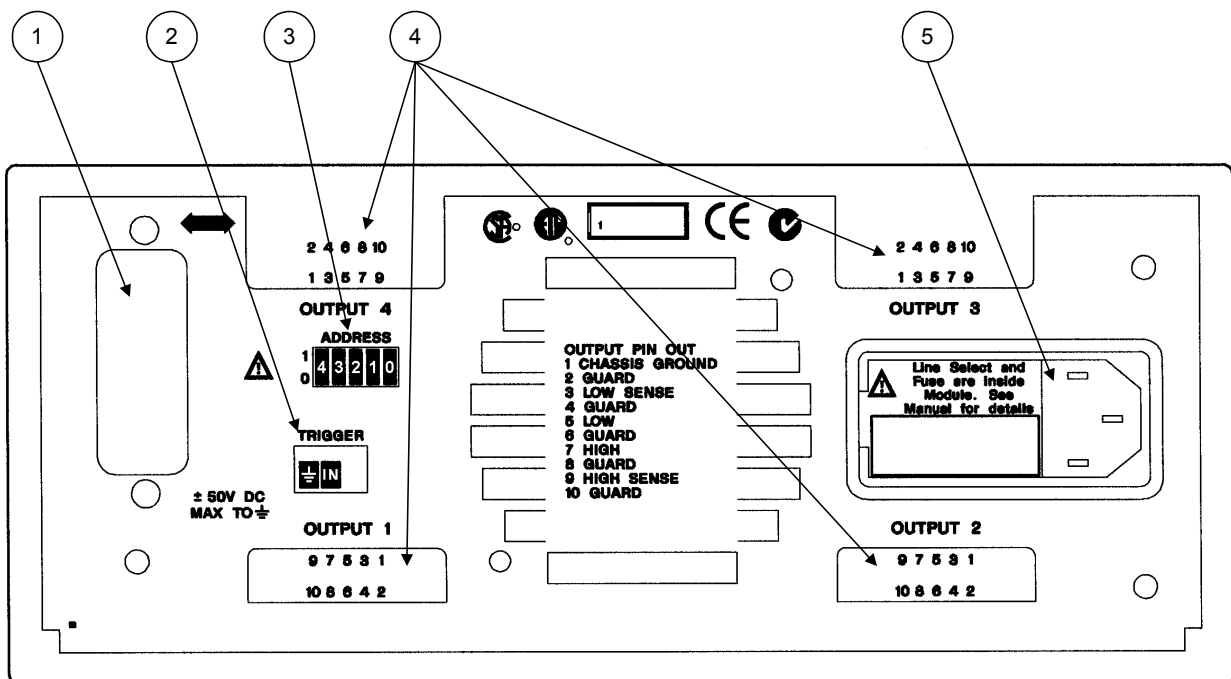

Figure 2-2. Rear Panel Connectors and Switches

① GPIB connector	GPIB connector for computer connection.
② Trigger Connector	A 3-terminal trigger input connector. Only the center and left-most terminals are used.
③ Address Switch	Switch to select GPIB address. Refer to the end of this chapter.
④ Output Connectors (4)	Pin 1 = chassis ground (do not guard chassis ground) Pin 3 = Low sense Pin 5 = Low output Pin 7 = High output Pin 9 = High sense Pins 2,4,6,8,10 = active guard connections for pins 3,5,7,9
⑤ Line	AC line cord is installed here. Also used to set the ac line voltage see Appendix E.

Output Connections

Turn the unit off before connecting any wires.

Outputs 1 - 4

The output connectors (outputs 1-4) have a termination for the Hi output and sense terminals, the Lo output and sense terminals, guard terminals, and an earth ground terminal (see figure 2-3). For proper operation of the dc source, you must connect the Hi sense and Lo sense terminals to their respective high and low monitoring points.

CAUTION: Connect the sense leads carefully so that they do not become open-circuited. If the sense leads are left unconnected or become open during operation, the dc source will revert to a local sense mode using internal sense protect resistors. This will result in an incorrect voltage being applied at the load terminals.

Mating output connector plugs are **NOT** supplied with the unit. The recommended 10-pin mating connector listed in table 2-2 accepts wires sizes from AWG 22 to AWG 24. Note that the wire connections for this mating plug are insulation displacement type, which require a special installation tool. You can order this tool directly from 3M company.

Open the latching tabs to connect and disconnect the mating plug from the unit.

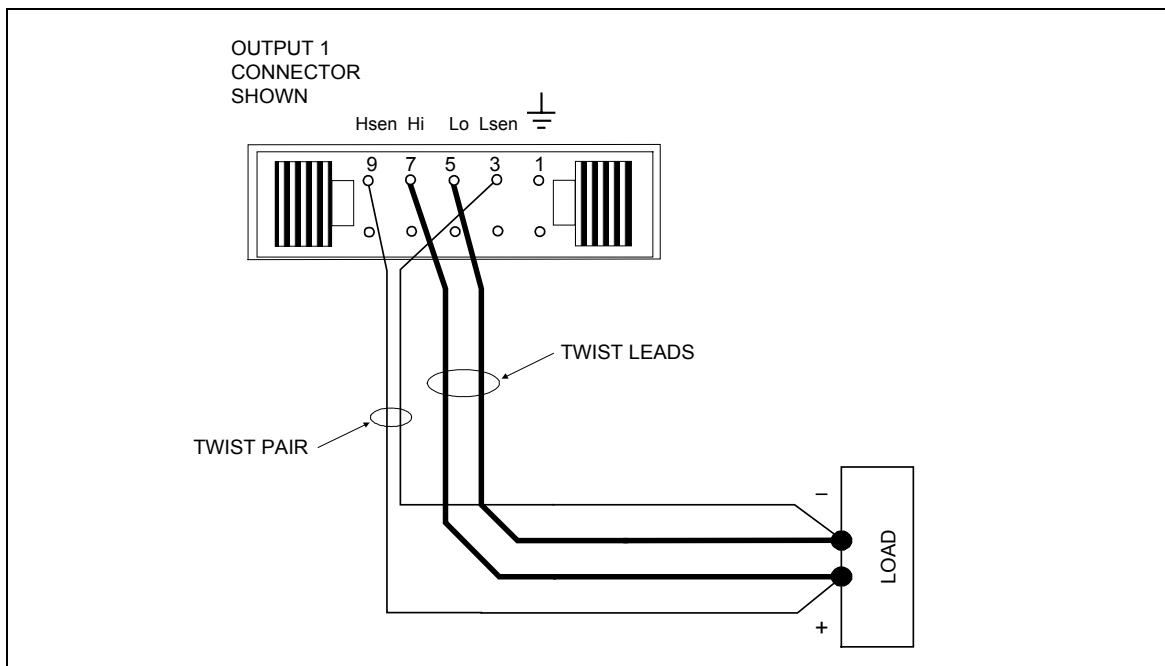

Figure 2-3. Remote Sense Connections

Figure 2-4 shows how to connect remote sense and load leads when using a removable test fixture. For best transient response and load regulation, keep the resistance and inductance as low as possible, as illustrated in the figure. The addition of a low-leakage RC network may help improve output transient response when the unit is operating in voltage priority mode.

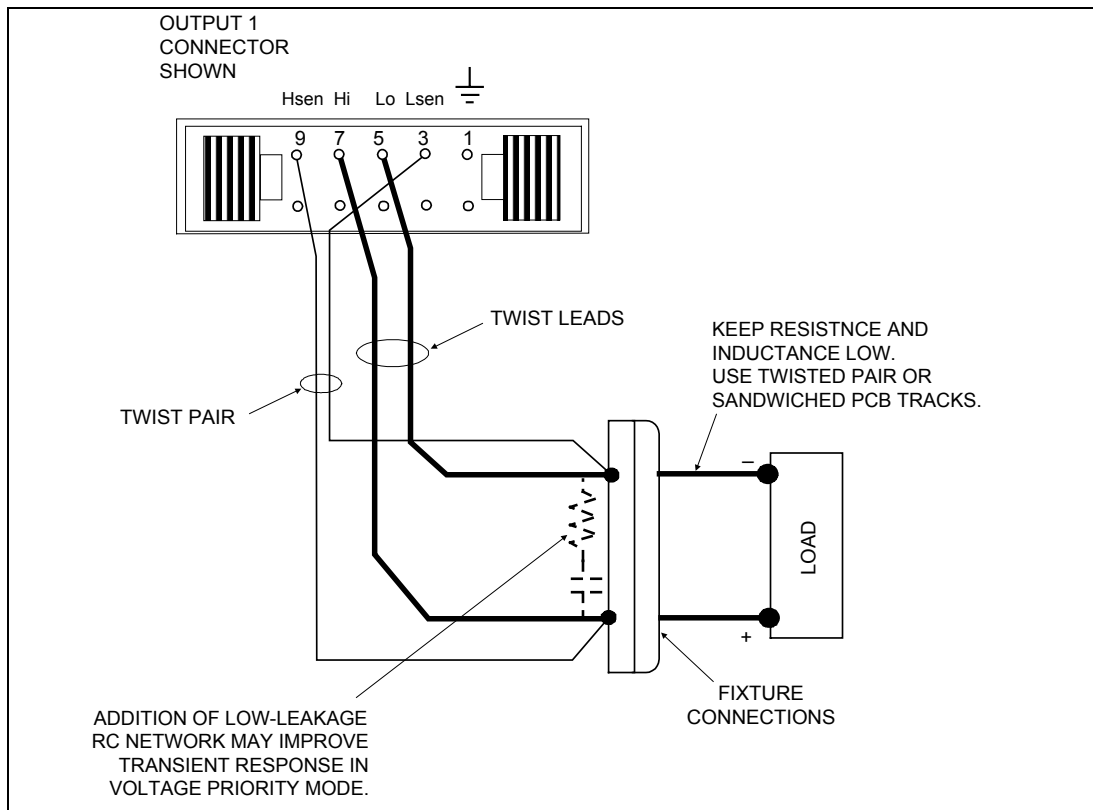

Figure 2-4. Remote Sense Connections with Test Fixture

Current Ratings

The following table lists the characteristics of AWG (American Wire Gauge) copper wire for the two wire sizes that can be accommodated in the output connectors.

Table 2-2. Ampacity and Resistance of Stranded Copper Conductors

AWG No.	Maximum Ampacity (in free air)	Resistance (at 20 deg. C)	
		Ω/m	Ω/ft
24	3.52	0.0843	0.0257
22	5.0	0.0531	0.0162

Voltage Drops and Lead Resistance

To optimize the performance and transient response in your test system, please observe the following guidelines:

- ◆ Twist the load leads together and keep them short. The shorter the leads, the better the performance.
- ◆ Twist the sense leads together, but do not bundle the sense leads with the load leads.
- ◆ For best performance, keep the total cable length to the load to about 5 meters (15 ft) or less.

The load wires must also be of a diameter large enough to avoid excessive voltage drops due to the impedance of the wires. In general, if the wires are heavy enough to carry the maximum short circuit current without overheating, excessive voltage drops will not be a problem.

NOTE: Any voltage drop in the load leads must be subtracted from the full scale voltage available at the output terminals.

Coaxial Guard Connections

Active guard connections are available at the output connector for output pins 3, 5, 7, and 9. When the guard connections are extended to a test fixture for example, they can be used to eliminate the effects of leakage current that can exist between the HI and LO output terminals when testing high-impedance devices. In particular, the HI output terminal and the HI sense terminal may benefit from guarding. In this way, any leakage current that is not load current will be collected by the circuit and not be included in the output current measurement.

The guard connections are always enabled and provide a buffered voltage that is at approximately the same potential as the HI output terminal. The output impedance of the guard is approximately 2.1K ohms.

You must order a special connector plug for coaxial cable connections (see table 2-2). Use the guard terminal to connect the shield of each coaxial cable. Coaxial cable and the special tool for making coaxial cable connections are available from 3M company.

If you are using tri-axial cables to extend the guard connection to the test fixture, use the center connector for the HI connection, the inner shield for the guard connection, and the outer shield as the LO connection (see figure 2-5).

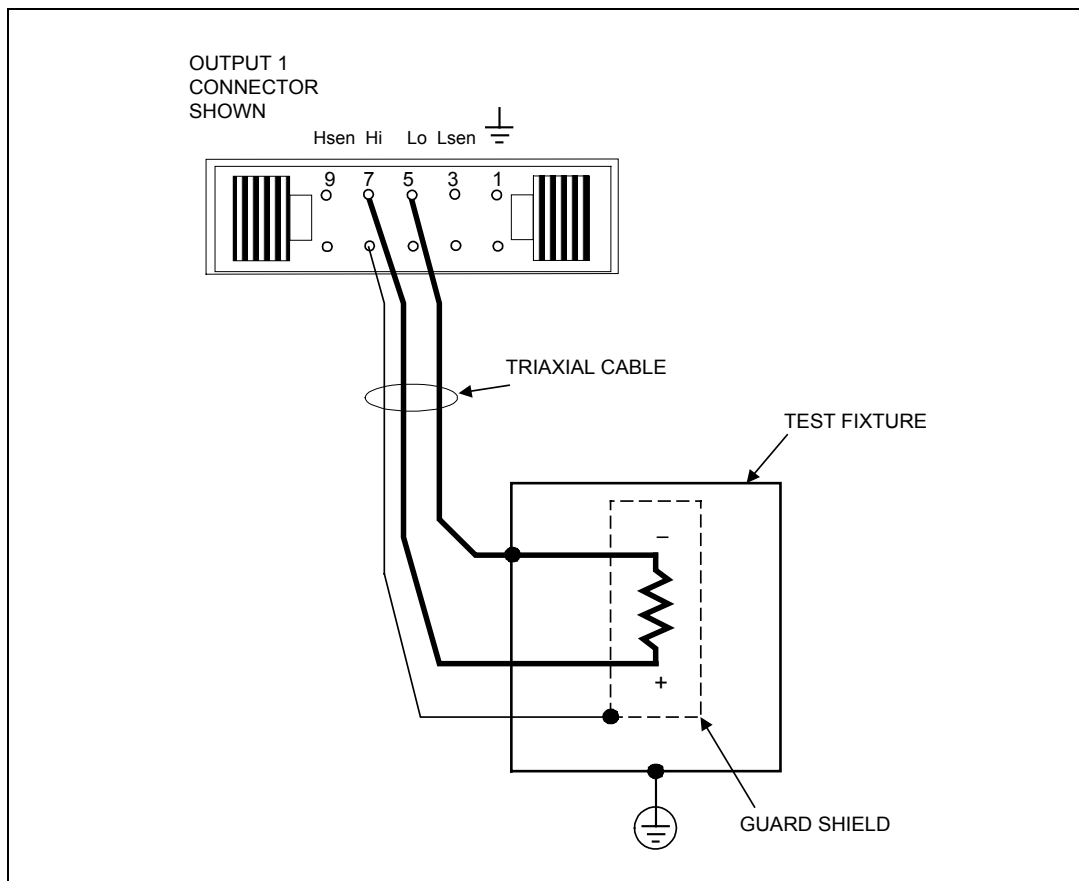

Figure 2-5. Guard Connections for Test Fixtures

Maintaining Stability

In voltage priority mode, the constant voltage loop has the following three compensation bandwidths:

- ◆ 30 kHz
- ◆ 20 kHz
- ◆ 10 kHz

If the output of your unit is being shut down by the oscillation protection circuit because of long load wires or a high Q load impedance, you can reprogram the output compensation bandwidth to try and eliminate the oscillation. As shipped from the factory, the compensation bandwidth is set to 30 kHz.

OVP Considerations

CAUTION: Disabling the OVP protection circuit may cause excessive output voltages, such as can occur if remote sense leads are shorted, to damage the equipment under test.

The dc source is shipped from the factory with its overvoltage protection circuit enabled. You can disable the OVP circuit using the `VOLTage:PROTection:STATe` command as explained in chapter 6. The overvoltage circuit automatically turns the output off and opens the output relays if the output voltage exceeds +11.5V (± 0.3 V) or -11.5V (± 0.3 V).

External Trigger Connections

This rear panel connector has an external trigger input.

The trigger input pin is normally at a TTL high level. To generate a trigger, you can provide a negative-going TTL signal to the trigger input, or momentarily connect a short (contact closure) from the trigger input pin to the chassis ground pin on the trigger connector. In any case, the device that you use to implement the trigger must be able to sink approximately 1mA.

The external trigger input can trigger both output voltage/current changes and output measurements.

Computer Connections

The dc source can be controlled through a GPIB interface.

GPIB Interface

Follow the GPIB card manufacturer's directions for card installation and software driver setup. Dc sources may be connected to the GPIB interface in series configuration, star configuration, or a combination of the two, provided the following rules are observed:

- ◆ The total number of devices including the GPIB interface card is no more than 15.
- ◆ The total length of all cables used is no more than 2 meters times the number of devices connected together, up to a maximum of 20 meters. (Refer to table 1-2 for a list of available GPIB cables.)
- ◆ Do not stack more than three connector blocks together on any GPIB connector.
- ◆ Make sure all connectors are fully seated and the lock screws are firmly finger-tightened.

2 - Installation

GPIB Address

Each dc source has its own GPIB bus address, which can be set using the rear panel **Address** switch. The dc source is shipped with its GPIB address set to 5. Refer to the following table for additional address switch positions.

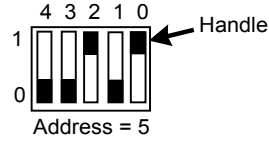

Table 2-3. Settings for Power Module Configuration Switch

GPIB Address	Switch Setting					GPIB Address	Switch Setting				
	4	3	2	1	0		4	3	2	1	0
0	0	0	0	0	0	8	0	1	0	0	0
1	0	0	0	0	1	9	0	1	0	0	1
2	0	0	0	1	0	10	0	1	0	1	0
3	0	0	0	1	1	11	0	1	0	1	1
4	0	0	1	0	0	12	0	1	1	0	0
5	0	0	1	0	1	13	0	1	1	0	1
6	0	0	1	1	0	14	0	1	1	1	0
7	0	0	1	1	1	15	0	1	1	1	1

Turn-On Checkout

Front Panel Description

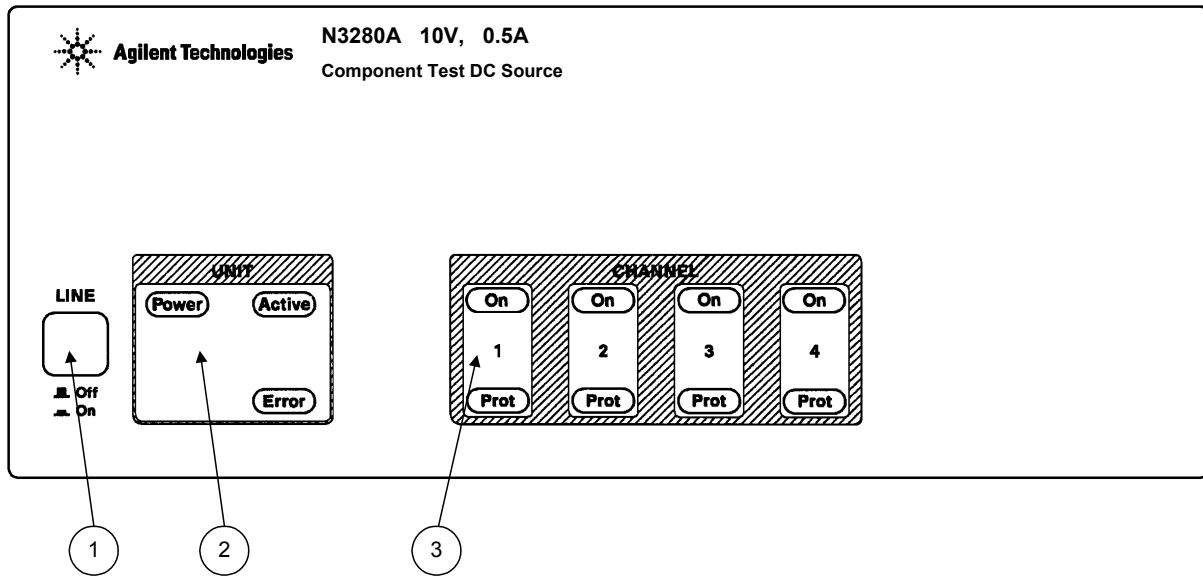

Figure 3-1. Front Panel, Overall View

<p>① Line Switch</p>	<p>AC mains power switch.</p>
<p>② Unit Indicators</p>	<p>Unit indicators light to indicate the following operating conditions: Power The dc source is turned on. Active The dc source is addressed to talk or listen. Error There is a message in the SCPI error queue.</p>
<p>③ Channel Indicators</p>	<p>Channel indicators light to indicate the following channel conditions: On The specified output channel is enabled. Prot The specified output channel has entered protection mode due to: Overtemperature, Overvoltage, Oscillation protect, or Power clear. Query the status registers of the affected channel to determine which protection feature is tripped.</p>

Checkout Procedure

Successful tests in this chapter provide a high degree of confidence that your unit is operating properly. Complete performance tests are given in Appendix B.

NOTE: To perform the checkout procedure, you will need a computer with a GPIB interface. You will also need a digital multimeter for making voltage and current measurements.

If you have not already done so, connect your unit to the computer's GPIB interface. Also connect the power cord to the unit and plug it in.

Procedure	Explanation
1. Connect the Hi sense terminal to the Hi terminal. Connect the Lo sense terminal to the Lo terminal. Connect the voltage inputs of the voltmeter across the Hi and Lo sense terminals of output 1.	The external voltmeter is used to verify the output.
2. Turn the unit on. The unit undergoes a self-test when you first turn it on.	During selftest, all indicators light simultaneously and then light individually in a clockwise manner to test the functionality of the display
3. Check that the fan is on.	You should be able to hear the fan and feel air coming from the back of the unit.
4. Program "Output On, (@1)"	Turn the output on.
5. Program "Voltage 10, (@1)"	Check the voltmeter display to verify the voltage programming.
6. Create a variable for a measurement. Program "Measure:Voltage? (@1)" Read the variable value.	Reads the voltage of output 1. This should agree with the value displayed on the voltmeter.
7. Program "Voltage -10, (@1)"	Check the voltmeter display to verify the voltage programming.
8. Program "Measure:Voltage? (@1)" Read the variable value.	Reads the voltage of output 1. This should agree with the value displayed on the voltmeter.
9. Program "Output Off, (@1)"	Turn the output off.
10. Connect the current measurement inputs of the ammeter across Hi and Lo output terminals of output 1. Observe polarity.	Use the ammeter to short the output of the unit and verify the output current.
11. Program "Output On, (@1)"	Turn the output on.
12. Program "Function:Mode CURR, (@1)"	Program the unit for current priority mode.
13. Program "Current 0.0005, (@1)"	
14. Create a variable for a measurement. Program "Measure:Current? (@1)" Read the variable value.	Reads the current of output 1. This should agree with the value displayed on the ammeter.
15. Program "Output Off, (@1)" Disconnect the multimeter.	Turn the output off.
16. Repeat steps 3 through 15 for outputs 2, 3, and 4.	Substitute the channel that you are programming after the @ symbol. For example, if you are programming channel 2, program "(@2)" in all commands.

In Case of Trouble

Dc source failure may occur during power-on selftest or during operation. Either the Error or the Prot indicator on the front panel may be lit to indicate that a failure has occurred. If this occurs, turn the power off and then back on to see if the error persists. If the error persists, the dc source requires service.

Selftest Error Messages

Error numbers and messages are read back with the SYSTem:ERRor? query. SYSTem:ERRor? returns an NR1 and a string error message.

Table 3-1. Power-On Selftest Errors

Error No.	Failed Test
Error 0	No error
Error 1	Output 1 non-volatile RAM CAL section checksum failed
Error 2	Output 2 non-volatile RAM CAL section checksum failed
Error 3	Output 3 non-volatile RAM CAL section checksum failed
Error 4	Output 4 non-volatile RAM CAL section checksum failed
Error 5	Non-volatile RAM CONFIG section checksum failed
Error 10	RAM selftest

Runtime Error Messages

Appendix C lists other error messages that may appear at runtime.

Line Fuse

If the dc source appears "dead" with the Power LCD off and the fan is not running, check your ac mains to be certain line voltage is being supplied to the dc source. Also check that the line module on the rear of the unit is set to the correct voltage. If the ac mains is normal, the internal line fuse may be defective.

Refer to Appendix E and follow the procedure described in the appendix for accessing and replacing the line fuse located inside the unit. **Unless the line voltage setting is incorrect, do not change the line voltage setting.**

NOTE: If the dc source has a defective fuse, replace it only once. If it fails again, the dc source requires service.

Introduction to Programming

External References

GPIB References

The most important GPIB documents are your controller programming manuals - BASIC, GPIB Command Library for MS DOS, etc. Refer to these for all non-SCPI commands (for example: Local Lockout). The following are two formal documents concerning the GPIB interface:

- ◆ *ANSI/IEEE Std. 488.1-1987 IEEE Standard Digital Interface for Programmable Instrumentation.* Defines the technical details of the GPIB interface. While much of the information is beyond the need of most programmers, it can serve to clarify terms used in this guide and in related documents.
- ◆ *ANSI/IEEE Std. 488.2-1987 IEEE Standard Codes, Formats, Protocols, and Common Commands.* Recommended as a reference only if you intend to do fairly sophisticated programming. Helpful for finding precise definitions of certain types of SCPI message formats, data types, or common commands.

The above two documents are available from the IEEE (Institute of Electrical and Electronics Engineers), 345 East 47th Street, New York, NY 10017, USA. The WEB address is www.ieee.org.

SCPI References

The following documents will assist you with programming in SCPI:

- ◆ *Standard Commands for Programmable Instruments Volume 1, Syntax and Style*
- ◆ *Standard Commands for Programmable Instruments Volume 2, Command References*
- ◆ *Standard Commands for Programmable Instruments Volume 3, Data Interchange Format*
- ◆ *Standard Commands for Programmable Instruments Volume 4, Instrument Classes*

To obtain a copy of the above documents, contact: Fred Bode, Executive Director, SCPI Consortium, 8380 Hercules Drive, Suite P3, Ls Mesa, CA 91942, USA

GPIB Capabilities of the DC Source

All dc source functions except for setting the GPIB address are programmable over the GPIB. The IEEE 488.2 capabilities of the dc source are listed in the Specifications table in Appendix A.

The dc source operates from an GPIB address that is set from the rear panel. To set the GPIB address, set the **Address** switches on the rear panel (see chapter 2). The address can be set from 0 to 30.

Introduction to SCPI

SCPI (Standard Commands for Programmable Instruments) is a programming language for controlling instrument functions over the GPIB. SCPI is layered on top of the hardware-portion of IEEE 488.2. The same SCPI commands and parameters control the same functions in different classes of instruments.

Conventions Used in This Guide

Angle brackets	< >	Items within angle brackets are parameter abbreviations. For example, <NR1> indicates a specific form of numerical data.
Vertical bar		Vertical bars separate alternative parameters. For example, VOLT CURR indicates that either "VOLT" or "CURR" can be used as a parameter.
Square Brackets	[]	Items within square brackets are optional. The representation [SOURce:]. VOLTage means that SOURce: may be omitted.
Braces	{ }	Braces indicate parameters that may be repeated zero or more times. It is used especially for showing arrays. The notation <A>{<,B>} shows that parameter "A" must be entered, while parameter "B" may be omitted or may be entered one or more times.
Parentheses	()	Items within parentheses are used in place of the usual parameter types to specify a channel list. The notation (@1:3) specifies a channel list that includes channels 1, 2, and 3. The notation (@1,3) specifies a channel list that includes only channels 1 and 3.
Computer font		Computer font is used to show program lines in text. TRIGger:ACQuire:SOURce BUS shows a program line.

Types of SCPI Commands

SCPI has two types of commands, common and subsystem.

- ◆ Common commands generally are not related to specific operation but to controlling overall dc source functions, such as reset, status, and synchronization. All common commands consist of a three-letter mnemonic preceded by an asterisk: *RST *IDN? *SRE 8
- ◆ Subsystem commands perform specific dc source functions. They are organized into an inverted tree structure with the "root" at the top. The following figure shows a portion of a subsystem command tree, from which you access the commands located along the various paths. You can see the complete tree in Appendix. D.

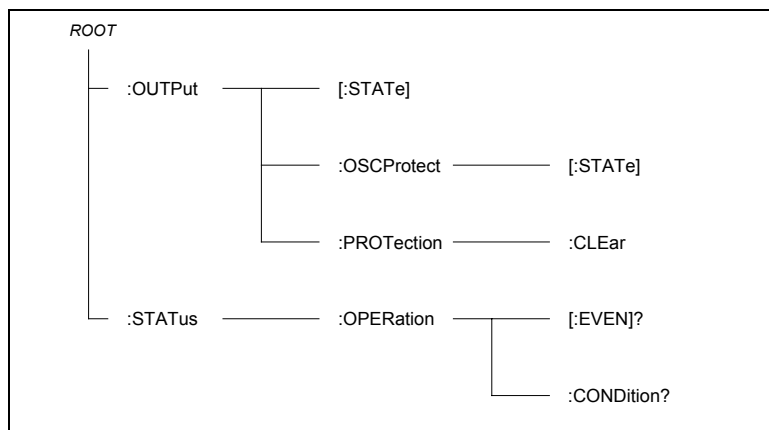

Figure 4-1. Partial Command Tree

Multiple Commands in a Message

Multiple SCPI commands can be combined and sent as a single message with one message terminator. There are two important considerations when sending several commands within a single message:

- ◆ Use a semicolon to separate commands within a message.
- ◆ There is an implied header path that affects how commands are interpreted by the dc source.

The header path can be thought of as a string that gets inserted **before** each command within a message. For the first command in a message, the header path is a null string. For each subsequent command the header path is defined as the characters that make up the headers of the previous command in the message up to and including the last colon separator. An example of a message with two commands is:

```
OUTPut:STATe ON, (@1);PROTection:CLEAr (@1)
```

which shows the use of the semicolon separating the two commands, and also illustrates the header path concept. Note that with the second command, the leading header "OUTPut" was omitted because after the "OUTPut:STATe ON" command, the header path was became defined as "OUTPut" and thus the instrument interpreted the second command as:

```
OUTPut:PROTection:CLEAr (@1)
```

In fact, it would have been syntactically incorrect to include the "OUTP" explicitly in the second command, since the result after combining it with the header path would be:

```
OUTPut:OUTPut:PROTection:CLEAr (@1)
```

which is incorrect.

Moving Among Subsystems

In order to combine commands from different subsystems, you need to be able to reset the header path to a null string within a message. You do this by beginning the command with a colon (:), which discards any previous header path. For example, you could clear the output protection and check the status of the Operation Condition register in one message by using a root specifier as follows:

```
OUTPut:PROTection:CLEAr (@1);:STATus:OPERation:CONDition? (@1)
```

The following message shows how to combine commands from different subsystems as well as within the same subsystem:

```
VOLTage:LEVel 7.5, (@1);PROTection ON, (@1);:CURRent:LIMit 0.25, (@1)
```

Note the use of the optional header LEVel to maintain the correct path within the subsystems, and the use of the root specifier to move between subsystems.

Including Common Commands

You can combine common commands with system commands in the same message. Treat the common command as a message unit by separating it with a semicolon (the message unit separator). Common commands *do not affect the header path*; you may insert them anywhere in the message.

```
VOLTage:TRIGgered 10, (@1);:INITiate:NAME TRAN;*TRG  
OUTPut OFF, (@1);*RCL 2;OUTPut ON, (@1)
```

Using Queries

Observe the following precautions with queries:

- ◆ Add a blank space between the query indicator (?) and any subsequent parameter such as a channel.
- ◆ Set up the proper number of variables for the returned data.
- ◆ Read back all the results of a query before sending another command to the dc source. Otherwise a *Query Interrupted* error will occur and the unreturned data will be lost.

Types of SCPI Messages

There are two types of SCPI messages, program and response.

- ◆ A *program message* consists of one or more properly formatted SCPI commands sent from the controller to the dc source. The message, which may be sent at any time, requests the dc source to perform some action.
- ◆ A *response message* consists of data in a specific SCPI format sent from the dc source to the controller. The dc source sends the message only when commanded by a program message "query."

Figure 4-2 illustrates the SCPI message structure.

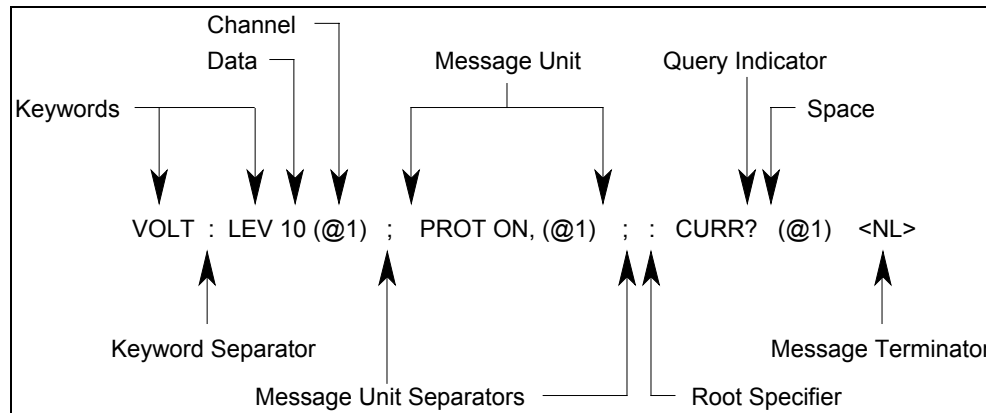

Figure 4-2. Command Message Structure

The Message Unit

The simplest SCPI command is a single message unit consisting of a command header (or keyword) followed by a message terminator. The message unit may include a parameter after the header. The parameter can be numeric or a string.

```
ABORt<NL>
VOLTage 20<NL>
```

Channel List Parameter

The channel parameter is required to address one or more channels. It has the following syntax:

```
(@<channel> [,<channel>][,<channel>][,<channel>])
```

You can also specify a range of sequential channels using the following syntax:

```
<start_channel> : <end_channel>
```

For example, (@2) specifies channel 2 and (@1:3) specifies channels 1 through 3. The Agilent N3280A only supports channels 1 through 4. A maximum of 4 channels may be specified through a combination of single channels and ranges. Query and measurement channel lists are order-sensitive. Results are returned in the order they are specified in the list.

NOTE: When adding a channel list parameter to a query, you must include a space (white space) between the query indicator (?) and the channel list parameter. Otherwise error -103, Invalid separator will occur

Headers

Headers, also referred to as keywords, are instructions recognized by the dc source. Headers may be either in the long form or the short form. In the long form, the header is completely spelled out, such as VOLTAGE, STATUS, and DELAY. In the short form, the header has only the first three or four letters, such as VOLT, STAT, and DEL.

Query Indicator

Following a header with a question mark turns it into a query (VOLTage?, VOLTage:TRIGgered?). If a query contains a parameter, place the query indicator at the end of the last header.

```
VOLTage:TRIGgered? MAX, (@1)
```

Message Unit Separator

When two or more message units are combined into a compound message, separate the units with a semicolon.

```
STATus:OPERation? (@1) ;QUESTionable? (@1)
```

Root Specifier

When it precedes the first header of a message unit, the colon becomes the root specifier. It tells the command parser that this is the root or the top node of the command tree.

Message Terminator

A terminator informs SCPI that it has reached the end of a message. Three permitted messages terminators are:

- ◆ newline (<NL>), which is ASCII decimal 10 or hex 0A.
- ◆ end or identify (<END>)
- ◆ both of the above (<NL><END>).

In the examples of this guide, there is an assumed message terminator at the end of each message.

SCPI Data Formats

All data programmed to or returned from the dc source is ASCII. The data may be numerical or character string.

Numerical Data Formats

<u>Symbol</u>	<u>Response Formats</u>
<NR1>	Digits with an implied decimal point assumed at the right of the least-significant digit. Examples: 273
<NR2>	Digits with an explicit decimal point. Example: .0273
<NR3>	Digits with an explicit decimal point and an exponent. Example: 2.73E+2
<u>Parameter Formats</u>	
<Nrf>	Extended format that includes <NR1>, <NR2> and <NR3>. Examples: 273 273. 2.73E2
<Nrf+>	Expanded decimal format that includes <Nrf> and MIN MAX . Examples: 273 273. 2.73E2 MAX. MIN and MAX are the minimum and maximum limit values that are implicit in the range specification for the parameter.
<Bool>	Boolean Data. Example: 0 1 or ON OFF

Suffixes and Multipliers

<u>Class</u>	<u>Suffix</u>	<u>Unit</u>	<u>Unit with Multiplier</u>
Current	A	ampere	MA (milliampere)
Amplitude	V	volt	MV (millivolt)
Time	S	second	MS (millisecond)
<u>Common Multipliers</u>			
	1E3	K	kilo
	1E-3	M	milli
	1E-6	U	micro

Response Data Types

Character strings returned by query statements may take either of the following forms, depending on the length of the returned string:

- <CRD> Character Response Data. Permits the return of character strings.
- <AARD> Arbitrary ASCII Response Data. Permits the return of unlimited 7-bit ASCII. This data type has an implied message terminator.
- <SRD> String Response Data. Returns string parameters enclosed in double quotes.

SCPI Command Completion

SCPI commands sent to the dc source are processed either sequentially or in parallel. Sequential commands finish execution before a subsequent command begins. Parallel commands allow other commands to begin executing while the parallel command is still executing. Commands that affect trigger actions are among the parallel commands.

Following is a list of parallel commands. A user should use some form of synchronization before assuming that these commands have completed.

OUTPUT : STATE	INITIATE
VOLT	OUTPUT : PROTECTION : CLEAR
CURR	FUNC : MODE
CURR : LIM	VOLT : ALC : BWIDTH

NOTE: The power supply already provides automatic source settling delay for the special case of VOLT, CURR, or CURR:LIM followed by a measure query, so it is not necessary to use *WAI before a measure if the only pending operations are in this group.

The *WAI, *OPC, and *OPC? common commands provide different ways of indicating when all transmitted commands, including any parallel ones, have completed their operations. The syntax and parameters for these commands are described in chapter 6. Some practical considerations for using these commands are as follows:

- *WAI This prevents the dc source from processing subsequent commands until all pending operations are completed.
- *OPC? This places a 1 in the Output Queue when all pending operations have completed. Because it requires your program to read the returned value before executing the next program statement, *OPC? can be used to cause the controller to wait for commands to complete before proceeding with its program.

*OPC This sets the OPC status bit when all pending operations have completed. Since your program can read this status bit on an interrupt basis, *OPC allows subsequent commands to be executed.

NOTE: The trigger subsystem must be in the Idle state for the status OPC bit to be true. As far as triggers are concerned, OPC is false whenever the trigger subsystem is in the Initiated state.

OUTPUT:STATE Example

OUTPUT:STATE ON starts a sequence of operations in the unit that closes the output and sense relays and sets the output voltage and current at the user's settings. It is often important to know when these parallel operations are finished, so that the next step in a test sequence can be synchronized with the completion of a power supply command.

Two types of synchronization are provided:

- ◆ *External* synchronization is required when the test system needs to control something other than the power supply after the power supply has finished all previous sent commands. External synchronization is provided by the *OPC? Query and the *OPC command. The *OPC? Query returns the value 1 when all pending operations are completed. The GPIB will be held up waiting for the response to the query until this occurs. The *OPC command will cause bit 0 of the standard event status register to be set when all pending operations are completed. The controller can either poll for this status bit or set up an SRQ when this occurs.
- ◆ *Internal* synchronization is required when the test system needs to change a power supply setting or make a power supply internal measurement after the supply has finished all previous sent commands. Internal synchronization is provided by the *WAI command. When the power supply receives the *WAI command, it holds up processing of any further bus commands until all pending parallel operations are completed. For example, the *WAI command can be used to make a current measurement after an output on command has completed:

```
OUTPUT ON, (@1) ; *WAI ; :MEAS:CURR 0.5, (@1)
```

Using Device Clear

You can send a device clear at any time abort a SCPI command that may be hanging up the GPIB interface. The status registers, the error queue, and all configuration states are left unchanged when a device clear message is received. Device clear performs the following actions:

- ◆ The input and output buffers of the dc source are cleared.
- ◆ The dc source is prepared to accept a new command string.

The following statement shows how to send a device clear over the GPIB interface using *Agilent BASIC*:

```
CLEAR 705 IEEE-488 Device Clear
```

The following statement shows how to send a device clear over the GPIB interface using the GPIB command library for *C* or *QuickBASIC*:

```
IOCLEAR (705)
```

Programming the DC Source

Introduction

This chapter contains examples on how to program your dc source. Simple examples show you how to program:

- ◆ output voltage and current functions
- ◆ internal and external triggers
- ◆ measurement functions
- ◆ the status and protection functions

NOTE: The examples in this chapter show which commands are used to perform a particular function, but do not show the commands being used in any particular programming environment.

Programming the Output

Power-on Initialization

When the dc source is first turned on, it wakes up with the output state set to OFF. In this state the output voltage is set to 0. The following commands are given implicitly at power-on:

```
*RST          *SRE 0          STAT: PRES
*CLS          *ESE 0
```

*RST is a convenient way to program all parameters to a known state. Refer to the Common Commands section in chapter 6 for a complete description of the above commands.

Enabling the Output

To enable all four outputs, use the command:

```
OUTP ON, (@1:4)      or   OUTP ON, (@1, 2, 3, 4)
```

To enable only outputs 1 and 3 use the command.

```
OUTP ON, (@1, 3)
```

Output Voltage

The output voltage is controlled with the VOLTage command. To set all four outputs to 5 volts, use:

```
VOLT 5, (@1:4)
```

The maximum output voltage that can be programmed can be queried with:

```
VOLT? MAX, (@<channel list>)
```

5 - Programming the DC Source

Overvoltage Protection

The dc source will turn off its output and open the output relays if the output voltage exceeds +11.5V ($\pm 0.3V$) or -11.5V ($\pm 0.3V$) when measured at the output terminals. Overvoltage protection is only available when operating in voltage priority mode. It is enabled with:

```
VOLT:PROT:STAT<bool>, (@<channel list>)
where <bool> is the protection state (0 | OFF; 1 | ON).
```

CAUTION: If overvoltage protection is disabled, the dc source or the equipment under test will not be protected from excessive external voltages.

Output Current

When operating in voltage priority mode, the dc source has a programmable current limit, which applies to both positive and negative output currents. The command to program the current limit is:

```
CURR:LIM <n>, (@<channel list>)
where <n> is the current limit in amperes.
```

If the load attempts to draw more current than the programmed limit, the output voltage is reduced to keep the current within the limit.

To query the maximum output current limit that can be programmed, use:

```
CURR:LIM? MAX, (@<channel list>)
```

When operating in current priority mode, the dc source has a programmable output current. The maximum output current that can be programmed in current priority mode is ± 0.5125 mA. The command to program the current is:

```
CURR <n>, (@<channel list>)
```

To query the programmed output current setting for output 1, use:

```
CURR?, (@<channel list>)
```

Output Mode

You can program the unit to operate in either voltage priority or current priority mode. In voltage priority mode the output is controlled by a constant voltage feedback loop, which maintains the output voltage at its programmed setting. In current priority mode the output is controlled by the constant current feedback loop, which maintains the output load or source current at its programmed setting.

Use the following command to configure the output mode:

```
FUNC:MODE <mode>, (@<channel list>)
where <mode> is the operating mode (VOLT | CURR)
```

NOTE: If the output is on, changing the output mode will cause the output to turn OFF, cycle modes, and then turn ON. Also, there is no interaction or coupling between modes. Switching back and forth between modes does not change the programmed values.

Oscillation Protection

Oscillation protection is a built in function that shuts down the output in about 10ms if a persistent and severe oscillation condition is detected. Oscillation protection can be enabled or disabled using the following command:

```
OUTP:OSCP <bool>, (@<channel list>) where <bool> is the protection state (0 | OFF | 1 | ON).
```

If the output of your unit is being shut down by the oscillation protection circuit, you can reprogram the output compensation bandwidth to try and eliminate the oscillation. This can be especially effective if capacitive loads or long load leads are causing the output to oscillate. You can program the output compensation to operate in a lower bandwidth using the following command:

```
VOLT:ALC:BWID <n>, (@<channel list>) where <n> is one of 3 bands (30000 | 20000 | 10000)
```

NOTE: If the output is on, changing the compensation will cause the output to cycle OFF, then ON.

Triggering Output Changes

The dc source has two independent trigger systems. One is used for triggering output changes, and the other is used for triggering measurements. This section describes the output trigger system. The measurement trigger system is described under "Triggering Measurements". Briefly, to generate an output trigger:

- 1 Program the triggered output level (voltage, current , or current limit)
- 2 Set the triggered function mode to STEP
- 3 Initiate the trigger system

Output Trigger Model

Figure 5-1 is a model of the output trigger system. The rectangular boxes represent states. Arrows show the transitions between states. Arrows are labeled with the event that causes the transition to occur.

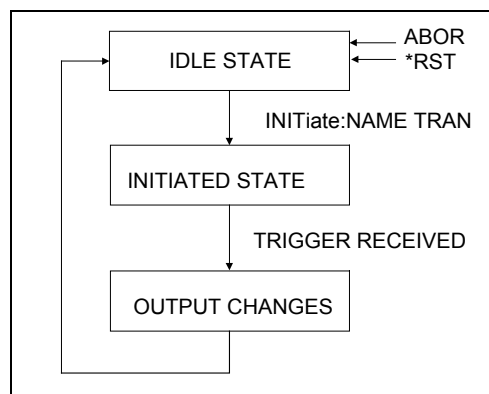

Figure 5-1. Model of Output Trigger System

Setting the Voltage and Current Trigger Levels

You can program a trigger level (or alternate value) that the output voltage, output current, or output current limit function will go to when a trigger is received. To use the output trigger function, you must first specify a voltage or current trigger level that the output will go to once a trigger signal is received.

Once you program a trigger level and then trigger the output, the output will stay at the triggered level until the output is reprogrammed. Use the following commands to program an output trigger level:

```
VOLT:TRIG <n>, (@<channel list>)  
CURR:TRIG <n>, (@<channel list>)  
CURR:LIM:TRIG <n>, (@<channel list>)
```

Once you have specified which function that you want to trigger, you must then enable that function to respond to trigger commands. Unless the function is enabled to respond to triggers, nothing will happen even if you have programmed a trigger level for the function. Use the following commands to enable a function to respond to triggers:

```
VOLT:MODE STEP, (@<channel list>)  
CURR:MODE STEP, (@<channel list>)  
CURR:LIM:MODE STEP, (@<channel list>)
```

In Step mode, the triggered value becomes the immediate value when the trigger is received. If the mode is set to Fixed, nothing will happen when a trigger is received; the immediate value remains in effect.

Enabling the Output Trigger System

When the dc source is turned on, the trigger subsystem is in the idle state. In this state, the trigger system is disabled, ignoring all triggers. Sending the following commands at any time returns the trigger system to the idle state:

```
ABOR  
*RST
```

The INITiate commands move the trigger system from the idle state to the initiated state. This enables the dc source to receive triggers. To initiate the trigger system, use:

```
INIT:NAME TRAN
```

After a trigger is received and the action completes, the trigger system will return to the idle state. Thus it will be necessary to enable the system each time a triggered action is desired.

Selecting the Output Trigger Source

The trigger system is waiting for a trigger signal in the initiated state. Before you generate a trigger, you must select a trigger source.

To select GPIB bus triggers, use:

```
TRIG[:TRAN]:SOUR BUS
```

To select external triggers use:

```
TRIG[:TRAN]:SOUR EXT
```

Generating Output Triggers

After you have specified the appropriate trigger source, you can generate triggers as follows:

GPIB Triggers Send one of the following commands over the GPIB:
 TRIG : IMM (not affected by the trigger source setting)
 *TRG
 an IEEE-488 Group Execute Trigger bus command

EXternal Triggers Provide a negative-going TTL signal to the trigger input.

When the trigger system enters the Output Change state upon receipt of a trigger (see figure 5-1), the triggered functions are set to their programmed trigger levels. When the triggered actions are completed, the trigger system returns to the Idle state.

Making Measurements

All measurements are performed by digitizing the instantaneous output voltage or current for a defined number of samples and sample interval, storing the results in a buffer, and then calculating the average.

NOTE: There is one measurement buffer for each output channel in the dc source. However, only the following measurement parameters can be configured independently for each channel: SENSE:FUNCTION, SENSE:CURRENT:RANGE.

There are two ways to make measurements:

- ◆ Use the MEASure queries to immediately start acquiring new voltage or current data, and return measurements from this data as soon as the buffer is full. This is the easiest way to make measurements, since it requires no explicit trigger programming.
- ◆ Use a triggered measurement when you need to synchronize the data acquisition with a transition in the output voltage or current. Then use the FETCh queries to return the measurement data. FETCH queries do not trigger the acquisition of new measurement data, they only return the data that was acquired by the trigger. Note that if you acquired voltage data, you can only fetch voltage data.

Average Measurements

To measure the average output voltage or current, use:

```
MEAS : VOLT? (@<channel list>)
MEAS : CURR? (@<channel list>)
```

Average voltage and current is measured by acquiring a number of readings at the selected time interval, applying the selected window function to the readings, and *averaging* the readings. Windowing is a signal conditioning process that reduces the error in average measurements made in the presence of periodic signals and noise. Refer to the discussion of the Window functions later in this chapter and in chapter 6. The power-on and *RST sample interval and sweep size settings yield a data acquisition time of 152 microseconds per measurement (5 data points at 30.4µs intervals).

Ripple rejection is a function of the number of cycles of the ripple frequency contained in the acquisition window. More cycles in the acquisition window results in better ripple rejection. The two methods of increasing data acquisition time is to either increase the number of power line cycles, or increase the number of measurement samples and the time interval between samples.

5 - Programming the DC Source

Power Line Cycles

After a power-on or *RST, the dc source automatically makes measurements based on a 0.00912 power line cycles (for 60 Hz line). This results in a default measurement sample of 5 points separated by 30.4 microsecond time intervals. The easiest way to increase the data acquisition time is to increase the number of power line cycles in the measurement. By doing this the unit automatically sets the sweep time interval, sweep offset, and sweep points, based on sampling the maximum number of points to provide the best noise filtering.

To change the power line cycles on which a measurement is based, use:

```
SENS : SWE : NPLC <n>
```

If your load does not draw currents with a significant noise component, use a setting of 0.00912 PLC for fast measurements. Use a setting of 1 PLC to achieve full accuracy on the 0.5mA current range.

Measurement Samples and Time Interval

You can vary both the number of data points in a measurement sample, as well as the time between samples. This is illustrated in figure 5-2.

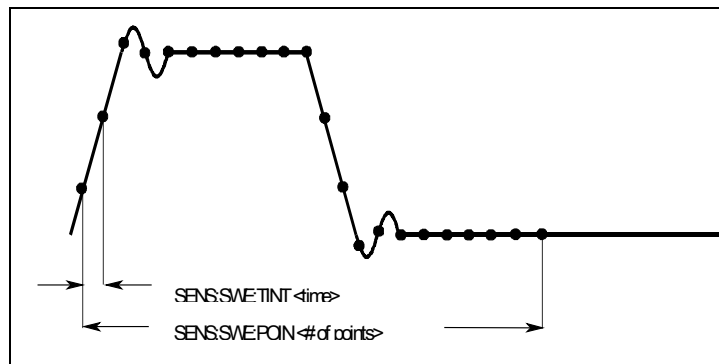

Figure 5-2. Commands that Control Measurement Time

When the instrument is turned on and at *RST, the output voltage or current sampling rate is 30.4 microseconds, and the sweep size is set to 5 data points. This means that it takes about 152 microseconds per measurement. You can vary this data sampling rate with:

```
SENS:SWE:TINT <sample period>  
SENS:SWE:POIN <points>
```

For example, to set the time interval to 60.8 microseconds per measurement with 1500 samples, use

```
SENS:SWE:TINT 60.8E-6;POIN 1500.
```

Note that increasing the number of sample points increases the accuracy of the measurement; however, the tradeoff is it takes a longer time to make the measurement.

NOTE: The total number of data points cannot exceed 4096. This means that the count multiplied by the points in each measurement cannot exceed 4096; otherwise an error will occur.

Current Ranges

The dc source has three current measurement ranges. The command that controls the ranges is:

```
SENS:CURR:RANG <value>, (@<channel list>)
```

Enter the value of the current that you expect to measure. When the range is set to MAX, the maximum current that can be measured is the maximum rating of the unit. Other measurement ranges are:

Range	Value to select range
0.5 A	values greater than 0.015A
15 mA	values greater than 0.0005A up to 0.015A
0.5 mA	values less than and up to 0.0005A

Window Functions

The dc source lets you select from two measurement window functions: Rectangular and Hanning. To select a window function, use:

```
SENS:WIND: HANN | RECT
```

At power-on, the dc source measurement window is Rectangular. The Rectangular window calculates average measurements without any signal conditioning. However, in the presence of periodic signals such as line ripple, a Rectangular window can introduce errors when calculating average measurements. This can occur due to the last partial cycle of acquired data when a non-integral number of cycles of data has been acquired. One way to overcome this limitation of the Rectangular window is to specify an integral number of power line cycles with SENSE:SWEep:NPLCycles before making a measurement. Another way of dealing with ac line ripple is to use a Hanning window.

The Hanning window applies a \cos^4 weighting function to the data in the measurement buffer when calculating average measurements. This attenuates the ac noise in the measurement window. The best attenuation is achieved when at least three or more waveform cycles are in the measurement buffer.

Returning All Measurement Data From the Data Buffer

The MEASure:ARRay and FETCh:ARRay queries return all data values of the instantaneous voltage or current buffer. No averaging is applied, only raw data is returned from the buffer. The commands are:

```
MEAS:ARR:CURR? (@<channel list>)
```

```
MEAS:ARR:VOLT? (@<channel list>)
```

Triggered Measurements

Use the measurement trigger system to synchronize the acquisition of measurements with either a BUS or an external trigger. Use FETCh commands to return voltage or current information from the data acquired by the measurement system. Briefly, to make a triggered measurement:

- 1 Select a sweep interval and sample size
- 2 Select the trigger source
- 3 Initiate the trigger system
- 4 Fetch the triggered measurements

Measurement Trigger Model

Figure 5-3 is a model of the measurement trigger system. The rectangular boxes represent states. The arrows show the transitions between states. These are labeled with the input or event that causes the transition to occur.

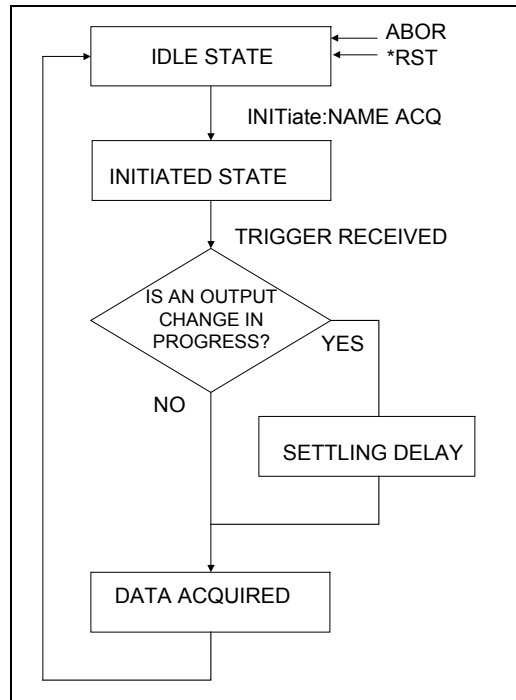

Figure 5-3. Model of Measurement Trigger System

Enabling the Measurement Trigger System

When the dc source is turned on, the trigger system is in the idle state. In this state, the trigger system is disabled and it ignores all triggers. Sending the following commands at any time returns the trigger system to the idle state:

```
ABORT  
*RST
```

The INITiate commands move the trigger system from the idle state to the initiated state. This enables the measurement system to receive triggers. To initiate the measurement trigger system, use:

```
INIT:NAME ACQ
```

After a trigger is received and the data acquisition completes, the trigger system will return to the idle state. Thus it will be necessary to initiate the system each time a triggered measurement is desired.

Selecting the Measurement Trigger Source

The trigger system is waiting for a trigger signal in the initiated state. Before you generate a trigger, you must select a trigger source. The following measurement trigger sources can be selected:

- BUS** - Selects GPIB bus triggers.
- EXTERNAL** - Selects the external trigger input as the trigger source.

To select GPIB bus triggers, use:

```
TRIG:ACQ:SOUR BUS
```

To select external triggers use:

```
TRIG:ACQ:SOUR EXT
```

Selecting the Sensing Function

Each output channel has its own measurement buffer. Since both voltage and current measurements are supported, you must specify a measurement function before you generate a measurement trigger. Use the following command to specify a measurement function:

```
SENS:FUNC "CURR", (@<channel list>) or
SENS:FUNC "VOLT", (@<channel list>)
```

Using this command makes it possible to measure output voltage on some channels while measuring output current on other channels.

Output Settling Delay

If an output change has been programmed to occur in conjunction with a measurement trigger, the dc source will delay the start of a measurement until the output has settled. This is an automatic function that allows the output to settle to approximately 0.1% of final value for a representative load that is a function of the selected sourcing mode. The representative load in voltage priority mode is a 20 ohm resistor with the current limit set to MAXimum. The representative load in current priority mode is a zero ohm short circuit.

To change the source settling delay, you must first change the source delay mode to MANual, then set a value for the delay time. Use the following commands:

```
SOUR:DEL:MODE MAN, (@<channel list>)
SOUR:DEL:<time>, (@<channel list>)    where <time> is specified in seconds.
```

The minimum time interval that can be programmed is specified by SENS:SWE:TINT. In addition to the minimum time interval, the delay time required for a given measurement accuracy is also function of load, measurement parameter, and required accuracy. It may be convenient to characterize the delay required for a particular load so that the test throughput can be optimized. Use the MEAS:ARRAY query to obtain a record of the voltage or current as a function of time after a source change, so that the best speed/accuracy tradeoff can be made.

Generating Measurement Triggers

After you specify the appropriate trigger source, sensing function, and optional settling delay, generate triggers as follows:

- GPIB Triggers** Send one of the following commands over the GPIB:
 TRIG:IMM (not affected by the trigger source setting)
 *TRG
 an IEEE-488 Group Execute Trigger bus command
- EXTERNAL Triggers** Provide a negative-going TTL signal to the trigger input.

5 - Programming the DC Source

When the acquisition finishes, any of the FETCh queries can be used to return the results. Once the measurement trigger is initiated, if a FETCh query is sent before the data acquisition is triggered or before it is finished, the response data will be delayed until the trigger occurs and the acquisition completes. This may tie up the computer if the trigger condition does not occur immediately.

One way to wait for results without tying up the computer is to use the SCPI command completion commands. For example, you can send the *OPC command after INITIALize, then occasionally poll the OPC status bit in the standard event status register for status completion while doing other tasks. You can also set up an SRQ condition on the OPC status bit going true and do other tasks until the SRQ interrupts.

Pre-trigger and Post-trigger Data Acquisition

The measurement system lets you capture data before, after, or at the trigger signal. When a measurement is initiated, the dc source continuously samples the instantaneous signal level of the sensing function. As shown in figure 5-4, you can move the block of data being read into the acquisition buffer with reference to the acquisition trigger. This permits pre-trigger or post-trigger data sampling.

To offset the beginning of the acquisition buffer relative to the acquisition trigger, use:

```
SENS:SWE:OFFS:POIN <offset>
```

The range for the offset is -4096 to 2,000,000,000 points. As shown in the figure, when the offset is negative, the values at the beginning of the data record represent samples taken prior to the trigger. When the value is 0, all of the values are taken after the trigger. Values greater than zero can be used to program a delay time from the receipt of the trigger until the data points that are entered into the buffer are valid. (Delay time = offset x sample period).

NOTE: If, during a pre-trigger data acquisition, a trigger occurs before the pre-trigger data count is completed, the measurement system ignores this trigger. This will prevent the completion of the measurement if another trigger is not generated.

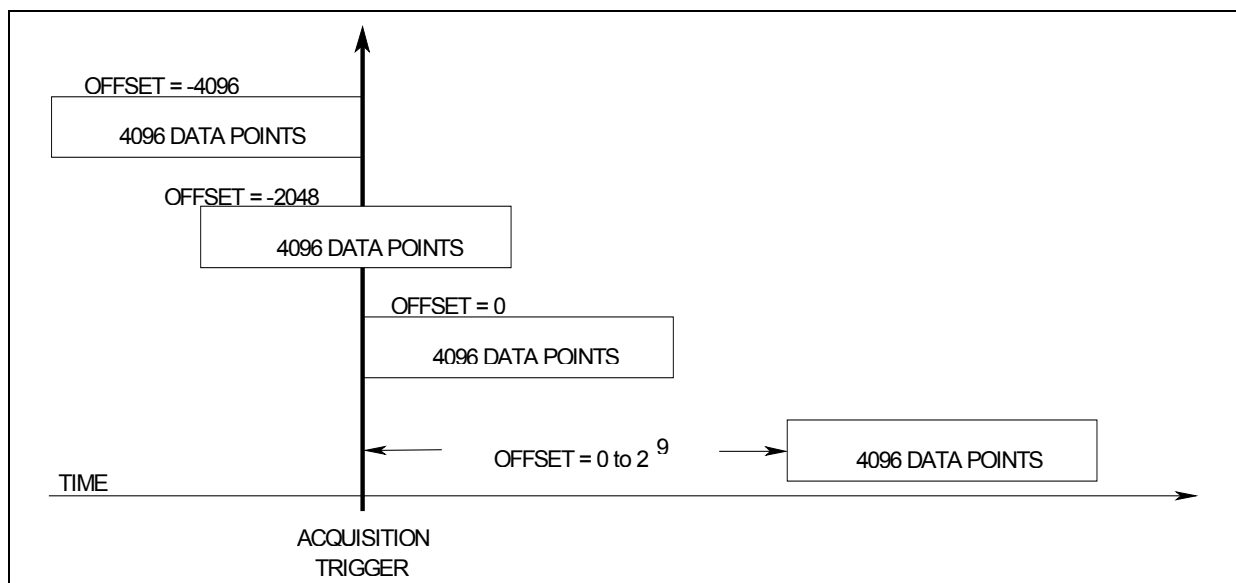

Figure 5-4. Pre-trigger and Post-trigger Acquisition

Programming the Status Registers

Status register programming lets you determine the operating condition of the dc source at any time. For example, you may program the dc source to generate an interrupt (SRQ) when an event such as a current limit occurs. When the interrupt occurs, your program can act on the event in the appropriate fashion.

Figure 5-5 shows the status register structure of the dc source. Table 5-1 defines the status bits. The Standard Event, Status Byte, and Service Request Enable registers and the Output Queue perform standard GPIB functions as defined in the *IEEE 488.2 Standard Digital Interface for Programmable Instrumentation*. The Operation Status and Questionable Status registers implement functions that are specific to the dc source.

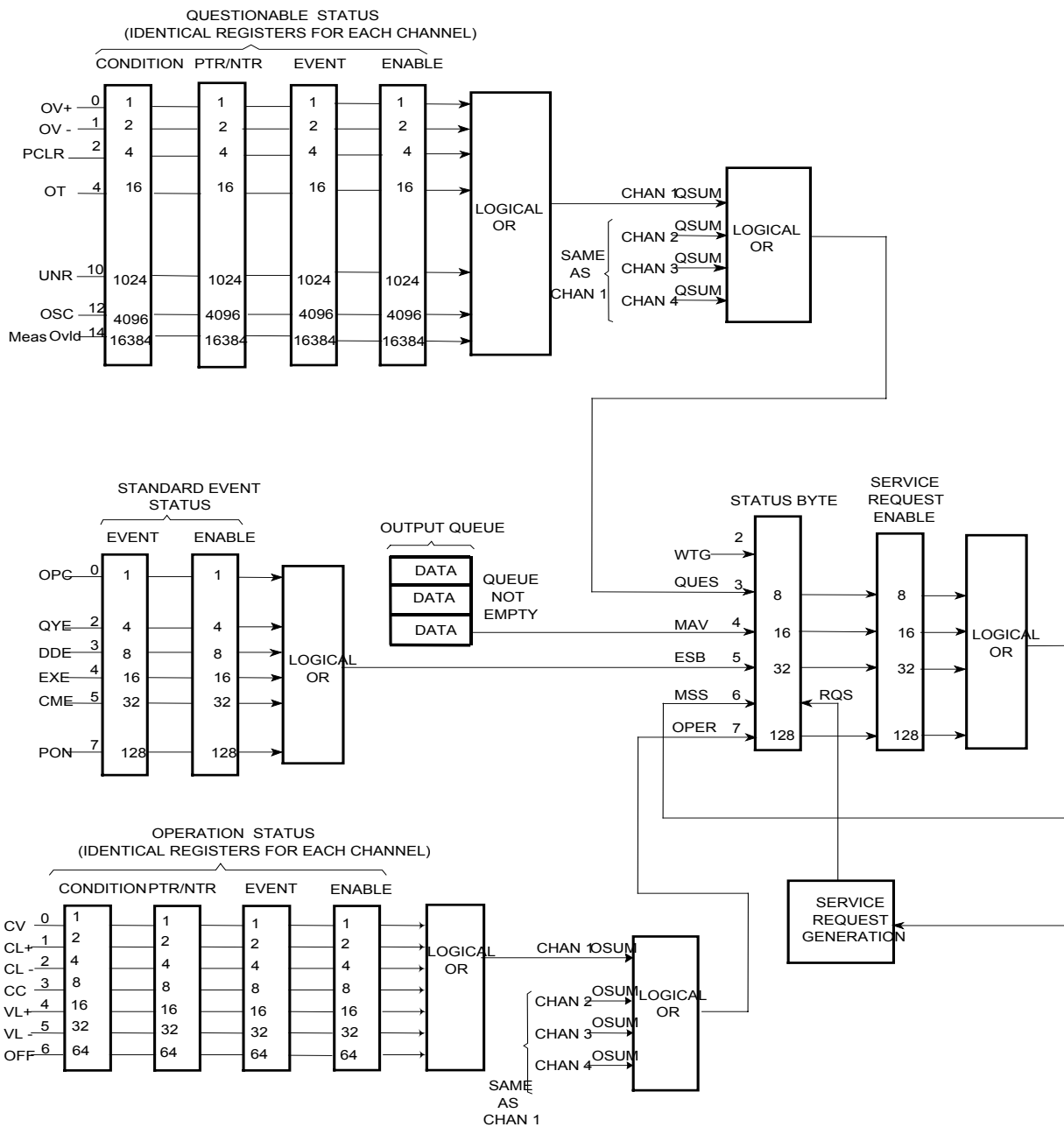

Figure 5-5. DC Source Status Model

5 - Programming the DC Source

Table 5-1. Bit Configurations of Status Registers

Bit	Signal	Meaning
Operation Status Group		
0	CV	The selected output is in constant voltage mode (applies only in voltage priority mode)
1	CL+	The selected output is in positive current limit (applies only in voltage priority mode)
2	CL-	The selected output is in negative current limit (applies only in voltage priority mode)
3	CC	The selected output is in constant current mode (applies only in current priority mode)
4	VL+	The selected output is in positive voltage limit (applies only in current priority mode)
5	VL-	The selected output is in negative voltage limit (applies only in current priority mode)
6	OFF	The selected output is OFF
Questionable Status Group		
0	OV+	The positive overvoltage protection has tripped
1	OV-	The negative overvoltage protection has tripped
2	PCLR	No communication with the selected output
4	OT	The overtemperature protection has tripped
10	UNR	The output is unregulated
12	OSC	The oscillation protection has tripped
14	MeasOvld	Output measurement exceeded capability of the range
Standard Event Status Group		
0	OPC	Operation complete
2	QYE	Query error
3	DDE	Device-dependent error
4	EXE	Execution error
5	CME	Command error
7	PON	Power-on
Status Byte and Service Request Enable Registers		
2	WTG	The unit is waiting for a trigger
3	QUES	Questionable status summary bit
4	MAV	Message Available summary bit
5	ESB	Event Status Summary bit
6	MSS	Master Status Summary bit
	RQS	Request Service bit
7	OPER	Operation status summary bit

Operation Status Group

The Operation Status registers record signals that occur during normal operation. As shown below, the group consists of a Condition, PTR/NTR, Event, and Enable register. The outputs of the Operation Status register group are logically-ORed into the OPERAtion summary bit (7) of the Status Byte register.

Register	Command	Description
Condition	STAT:OPER:COND? (@<channel list>)	A register that holds real-time status of the circuits being monitored. It is a read-only register.
PTR Filter	STAT:OPER:PTR <n> (@<channel list>)	A positive transition filter that functions as described under STAT:OPER:NTR PTR commands in chapter 6. It is a read/write register.
NTR Filter	STAT:OPER:NTR <n> (@<channel list>)	A negative transition filter that functions as described under STAT:OPER:NTR PTR commands in chapter 6. It is a read/write register.
Event	STAT:OPER:EVEN? (@<channel list>)	A register that latches any condition that is passed through the PTR or NTR filters. It is a read-only register that is cleared when read.
Enable	STAT:OPER:ENAB <n> (@<channel list>)	A register that functions as a mask for enabling specific bits from the Event register. It is a read/write register.

Questionable Status Group

The Questionable Status registers record signals that indicate abnormal operation. As shown below, the group consists of the same register types as the Status Operation group. The outputs of the Questionable Status group are logically-ORed into the QUESTionable summary bit (3) of the Status Byte register.

Register	Command	Description
Condition	STAT:QUES:COND? (@<channel list>)	A register that holds real-time status of the circuits being monitored. It is a read-only register.
PTR Filter	STAT:QUES:PTR <n> (@<channel list>)	A positive transition filter that functions as described under STAT:QUES:NTR PTR commands in chapter 6. It is a read/write register.
NTR Filter	STAT:QUES:NTR <n> (@<channel list>)	A negative transition filter that functions as described under STAT:QUES:NTR PTR commands in chapter 6. It is a read/write register.
Event	STAT:QUES:EVEN? (@<channel list>)	A register that latches any condition that is passed through the PTR or NTR filters. It is a read-only register that is cleared when read.
Enable	STAT:QUES:ENAB <n> (@<channel list>)	A register that functions as a mask for enabling specific bits from the Event register. It is a read/write register..

Standard Event Status Group

This group consists of an Event register and an Enable register that are programmed by Common commands. The Standard Event event register latches events relating to instrument communication status (see figure 5-5). It is a read-only register that is cleared when read. The Standard Event enable register functions similarly to the enable registers of the Operation and Questionable status groups.

Command	Action
*ESE	programs specific bits in the Standard Event enable register.
*ESR?	reads and clears the Standard Event event register.

Status Byte Register

This register summarizes the information from all other status groups as defined in the *IEEE 488.2 Standard Digital Interface for Programmable Instrumentation*. See Table 5-1 for the bit configuration.

Command	Action
*STB?	reads the data in the register but does not clear it (returns MSS in bit 6)
serial poll	clears RQS inside the register and returns it in bit position 6 of the response.

The MSS and RQS Bits

MSS is a real-time (unlatched) summary of all Status Byte register bits that are enabled by the Service Request Enable register. MSS is set whenever the dc source has one or more reasons for requesting service. *STB? reads the MSS in bit position 6 of the response but does not clear any of the bits in the Status Byte register.

The RQS bit is a latched version of the MSS bit. Whenever the dc source requests service, it sets the SRQ interrupt line true and latches RQS into bit 6 of the Status Byte register. When the controller does a serial poll, RQS is cleared inside the register and returned in bit position 6 of the response. The remaining bits of the Status Byte register are not disturbed.

The MAV Bit and Output Queue

The Output Queue is a first-in, first-out (FIFO) data register that stores dc source-to-controller messages until the controller reads them. Whenever the queue holds one or more bytes, it sets the MAV bit (4) of the Status Byte register.

5 - Programming the DC Source

Determining the Cause of a Service Interrupt

You can determine the reason for an SRQ by the following actions:

- Step 1 Determine which summary bits are active. Use:
*STB? or serial poll
- Step 2 Read the corresponding Event register for each summary bit to determine which events caused the summary bit to be set. Use:
STAT:QUES:EVEN? (@<channel list>)
STAT:OPER:EVEN? (@<channel list>)
ESR?
- When an Event register is read, it is cleared. This also clears the corresponding summary bit.
- Step 3 Remove the specific condition that caused the event. If this is not possible, the event may be disabled by programming the corresponding bit of the status group Enable register or NTR|PTR filter. A faster way to prevent the interrupt is to disable the service request by programming the appropriate bit of the Service Request Enable register.

Servicing Operation Status and Questionable Status Events

This example assumes you want a service request generated whenever the dc source switches to the CC (constant current) operating mode, or whenever the dc source's overvoltage, overcurrent, or overtemperature circuits have tripped. From figure 5-5, note the required path for a condition at bit 10 (CC) of the Operation Status register to set bit 6 (RQS) of the Status Byte register. Also note the required path for Questionable Status conditions at bits 0, 1, and 4 to generate a service request (RQS) at the Status Byte register. The required register programming is as follows:

- Step 1 Program the Operation Status PTR register to allow a positive transition at bit 6 to be latched into the Operation Status Event register, and allow the latched event to be summed into the Operation summary bit. Use:
STAT:OPER:PTR 64, (@<channel list>); ENAB 64, (@<channel list>)
- Step 2 Program the Questionable Status PTR register to allow a positive transition at bits 0, 1, or 4 to be latched into the Questionable Status Event register, and allow the latched event to be summed into the Questionable summary bit. Use:
STAT:QUES:PTR 19, (@<channel list>); ENAB 19, (@<channel list>) (1 + 2 + 16 = 19)
- Step 3 Program the Service Request Enable register to allow both the Operation and the Questionable summary bits from the Status Byte register to generate RQS. Use:
*SRE 136 (8 + 128 = 136)
- Step 4 When you service the request, read the event registers to determine which Operation Status and Questionable Status Event register bits are set, and clear the registers for the next event. Use:
STAT:OPER:EVEN? (@<channel list>); QUES:EVEN? (@<channel list>)

You can also monitor a status signal for both its positive and negative transitions. For example, to generate RQS when the dc source either enters the CC+ (constant current) condition or leaves that condition, program the Operational Status PTR/NTR filter as follows:

```
STAT:OPER:PTR 8, (@<channel list>); NTR 8, (@<channel list>)  
STAT:OPER:ENAB 8, (@<channel list>); *SRE 128, (@<channel list>)
```

Language Dictionary

Introduction

This section gives the syntax and parameters for all the IEEE 488.2 SCPI commands and the Common commands used by the dc source. It is assumed that you are familiar with the material in chapter 4, which explains the terms, symbols, and syntactical structures used here and gives an introduction to programming. You should also be familiar with chapter 5, in order to understand how the dc source functions.

The programming examples are simple applications of SCPI commands. Because the SCPI syntax remains the same for all programming languages, the examples given for each command are generic.

Syntax Forms	Syntax definitions use the long form, but only short form headers (or "keywords") appear in the examples. Use the long form to help make your program self-documenting.
Parameters	Most commands require a parameter and all queries will return a parameter. The range for a parameter may vary according to the model of dc source. When this is the case, refer to the Specifications table in Appendix A.
Related Commands	Where appropriate, related commands or queries are included. These are listed because they are either directly related by function, or because reading about them will clarify or enhance your understanding of the original command or query.
Order of Presentation	The dictionary is organized according to the following functions: calibration, display, measurement, output, status, system, trigger, and common commands. Both the subsystem commands and the common commands that follow are arranged in alphabetical order under each heading.

Subsystem Commands

Subsystem commands are specific to functions. They can be a single command or a group of commands. The groups are comprised of commands that extend one or more levels below the root.

The subsystem command groups are arranged according to function: Calibration, Display, Measurement, Output, Status, System, and Trigger. Commands under each function are grouped alphabetically. Commands followed by a question mark (?) take only the query form. When commands take both the command and query form, this is noted in the syntax descriptions. Table 6-1 lists all of the subsystem commands in alphabetical order.

Common Commands

Common commands begin with an * and consist of three letters (command) or three letters and a ? (query). They are defined by the IEEE 488.2 standard to perform common interface functions. Table 6-2 lists all of the common commands in alphabetical order.

Programming Parameters

Table 6-3 lists all of the output programming parameters.

SCPI Programming Commands - At a Glance

Table 6-1. Subsystem Commands Syntax

ABORt	Resets the trigger system to the Idle state
CALibrate	
:CURRent	
[:LEVEL] (@channel)	Calibrate output current and low current measurement range
:LIMit	
[:POSitive] (@channel)	Calibrate positive current limit
:NEGative (@channel)	Calibrate negative current limit
:MEASure <max_val>, (@channel)	Calibrate high and medium current measurement range
:DATA <n>	Enters the calibration value
:DATE <date>	Sets the calibration date
:LEVel <level>	Advance to next calibration step (P1 P2)
:PASSword <n>	Set numeric calibration password
:SAVE	Save new cal constants in non-volatile memory
:STATE <bool> [,<n>]	Enable or disable calibration mode
:VOLTagE (@channel)	Calibrate output voltage and voltage measurement range
INITiate	
[:IMMEDIATE]	
:NAME <name>	Enable the named trigger system (TRANsient ACQuire)
FETCh	
:ARRay	
:CURRent [:DC]? (@list)	Returns the digitized instantaneous current
:VOLTagE [:DC]? (@list)	Returns the digitized instantaneous voltage
[:SCALar]	
:CURRent [:DC]? (@list)	Returns output current dc measurement
:VOLTagE [:DC]? (@list)	Returns output voltage dc measurement
MEASure	
:ARRay	
:CURRent [:DC]? [max_val,] (@list)	Digitizes and returns the instantaneous output current
:VOLTagE [:DC]? (@list)	Digitizes and returns the instantaneous output voltage
[:SCALar]	
:CURRent [:DC]? [max_val,] (@list)	Digitizes and returns average (dc) output current
:VOLTagE [:DC]? (@list)	Digitizes and returns average (dc) output voltage
OUTPut	
[:STATe] <bool>, (@list)	Enables/disables the selected dc source output
:OSCProtect	
[:STATe] <bool>, (@list)	Enables/disables oscillation protection on the selected output
:PROTection	
:CLEar (@list)	Reset latched protection
SENSe	
:CURRent[:DC]	
:RANGe [:UPPer] <max_val>, (@list)	Selects the current measurement range
:FUNCTion <function>, (@list)	Configures the measurement sensor ("VOLTagE" "CURRent")
:SWEep	
:NPLCycles <n>	Sets the number of ac power line cycles
:OFFSet	
:POINts <n>	Defines the trigger offset in the measurement sweep
:POINts <n>	Defines the number of data points in the measurement
:TINTerval <n>	Sets the measurement sample interval
:WINDow [:TYPE] <type>	Sets measurement window function (HANNing RECTangular)

Table 6-1. Subsystem Commands Syntax (continued)

[SOURCE:]	
CURRENT	
[:LEVEl]	
[:IMMediate][:AMPLitude] <n>, (@list)	Sets the output current (in current priority mode)
:TRIGgered [:AMPLitude] <n>, (@list)	Sets the triggered output current (in current priority mode)
:LIMit [:POSitive]	
[:IMMediate][:AMPLitude] <n>, (@list)	Sets the current limit (in voltage priority mode)
:TRIGgered [:AMPLitude] <n>, (@list)	Sets the triggered current limit (in voltage priority mode)
:MODE <mode>, (@list)	Sets the current trigger mode (FIXEd STEP)
DELay	
[:TIME] <n>, (@list)	Sets the output settling delay time in Manual mode
:MODE <mode>, (@list)	Sets the output settling delay mode (AUTO MANUal)
FUNCTION	
:MODE <mode>, (@list)	Sets the output mode (VOLTage CURRent)
VOLTage	
:ALC	
:BWIDth <bandwidth> , (@list)	Sets the output compensation bandwidth
[:LEVEl]	
[:IMMediate][:AMPLitude] <n>, (@list)	Sets the output voltage (in voltage priority mode)
:TRIGgered [:AMPLitude] <n>, (@list)	Sets the triggered output voltage (in voltage priority mode)
:MODE <mode>, (@list)	Sets the voltage trigger mode (FIXEd STEP)
:PROTection	
[:STATe] <bool>, (@list)	Enables/disables overvoltage protection on the selected output
STATus	
:OPERation	
[:EVENT]? (@list)	Returns the value of the event register
:CONDition? (@list)	Returns the value of the condition register
:ENABle <n>, (@list)	Enables specific bits in the Event register
:NTRansition<n>, (@list)	Sets the Negative transition filter
:PTRansition<n>, (@list)	Sets the Positive transition filter
:PRESet	Presets all enable and transition registers to power-on
:QUESTionable	
[:EVENT]? (@list)	Returns the value of the event register
:CONDition? (@list)	Returns the value of the condition register
:ENABle <n>, (@list)	Enables specific bits in the Event register
:NTRansition<n>, (@list)	Sets the Negative transition filter
:PTRansition<n>, (@list)	Sets the Positive transition filter
SYSTEM	
:ERRor?	Returns the error number and error string
:VERSion?	Returns the SCPI version number
TRIGger	
:ACQuire	
[:IMMediate]	Triggers the measurement immediately
:SOURce <source>	Sets the measurement trigger source (BUS EXTErnal)
[:TRANsient]	
[:IMMediate]	Triggers the output immediately
:SOURce <source>	Sets the output trigger source (BUS EXTErnal)

NOTE: Some [optional] commands have been included for clarity. Refer to chapter 6 for a complete description of all programming commands.

Table 6-2. Common Commands Syntax

*CLS	Clear status
*ESE <n>	Standard event status enable
*ESE?	Return standard event status enable
*ESR?	Return event status register
*IDN?	Return instrument identification
*OPC	Enable "operation complete" bit in ESR
*OPC?	Return a "1" when operation complete
*OPT?	Return option number
*RST	Reset
*SRE <n>	Set service request enable register
*SRE?	Return service request enable register
*STB?	Return status byte
*TRG	Trigger
*TST?	Perform selftest, then return result
*WAI	Hold off bus until all device commands done

Table 6-3. Output Programming Parameters

Parameter	Value
[SOUR:]CURR[:LEV][:IMM] and [SOUR:]CURR[:LEV]:TRIG	-0.5125 mA to +0.5125 mA
[SOUR:]CURR:LIM[:IMM] and [SOUR:]CURR:LIM:TRIG	+75 μ A to +0.5125 A -75 μ A to -0.5125 A
*RST Current [Level] Value	0 A
*RST Current Limit Value	75 μ A
[SOUR:]VOLT[:LEV][:IMM] and [SOUR:]VOLT[:LEV]:TRIG	-10.25 V to +10.25 V
*RST Voltage Value	0 V
[SOUR:]DEL	0 – 1000

Calibration Commands

Calibration commands let you enable and disable the calibration mode, change the calibration password, calibrate current and voltage programming, and store new calibration constants in nonvolatile memory. Only one output channel may be calibrated at a time.

NOTE: If calibration mode has not been enabled with CALibrate:STATe, programming the calibration commands will generate an error. You must also save any changes that you made using CALibrate:SAVE, otherwise all changes will be lost when you exit calibration mode.

CALibrate:CURRENT

This command initiates the calibration of the current priority mode as well as the 0.5mA current range measurement circuit.

Command Syntax	CALibrate:CURRENT[:LEVel] (@<channel>)
Parameters	None
Examples	CAL:CURR (@1) ! start current calibration
Related Commands	CAL:CURR:LIM, CAL:CURR:MEAS

CALibrate:CURRENT:LIMit[:POSitive] CALibrate:CURRENT:LIMit:NEGative

This command initiates the calibration of the positive or negative current limit.

Command Syntax	CALibrate:CURRENT:LIMit[:POSitive] (@<channel>)
	CALibrate:CURRENT:LIMit:NEGative (@<channel>)
Parameters	None
Examples	CAL:CURR:LIM (@1)
	CAL:CURR:LIM:NEG (@1)
Related Commands	CAL:CURR CAL:CURR:MEAS

CALibrate:CURRENT:MEASure

This command initiates the calibration of the 0.5A or 15mA current range measurement circuit.

Command Syntax	CALibrate:CURRENT:MEASure <NRf>, (@<channel>)
Parameters	A value that falls within the 0.5A or 15mA current range
Unit	A (amperes)
Examples	CAL:CURR:MEAS 0.5, (@1) !0.5A range
	CAL:CURR:MEAS 0.005, (@1) !15mA range
Related Commands	CAL:CURR, CAL:CURR:LIM

CALibrate:DATA

This command enters a calibration value that you obtain by reading an external meter. You must first select a calibration level (with CALibrate:LEVel) for the value being entered.

Command Syntax	CALibrate:DATA <NRf>
Parameters	<external reading>
Unit	A or V (amperes or volts)
Examples	CAL:DATA 3222.3 MA CAL:DATA 5.000
Related Commands	CAL:STAT CAL:LEV

CALibrate:DATE

This command stores the date the unit was last calibrated. Enter any ASCII string up to 31 characters.

Command Syntax	CALibrate:DATE <date>
Parameters	<date>
Examples	CAL:DATE "3/22/01" CAL:DATE "22.3.99"
Query Syntax	CALibrate:DATE?
Returned Parameters	<SRD>

CALibrate:LEVel

This command selects the next point in the calibration sequence. **P1** is the first calibration point, **P2** is the second calibration point.

Command Syntax	CALibrate:LEVel <point>
Parameters	P1 P2
Examples	CAL:LEV P2

CALibrate:PASSword

This command lets you change the calibration password. A new password is automatically stored in nonvolatile memory and does not have to be stored with CALibrate:SAVE. The default password is the model number of the unit. If the password is set to 0, password protection is removed and the ability to enter the calibration mode is unrestricted.

Command Syntax	CALibrate:PASSword <NRf>
Parameters	<model number> (default)
Examples	CAL:PASS 1234
Related Commands	CAL:SAV

CALibrate:SAVE

This command saves any new calibration constants after a calibration procedure has been completed in nonvolatile memory. If CALibrate:STATe OFF is programmed without a CALibrate:SAVE, the previous calibration constants are restored..

Command Syntax	CALibrate:SAVE
Parameters	None
Examples	CAL:SAVE
Related Commands	CAL:PASS CAL:STAT

CALibrate:STATE

This command enables and disables calibration mode. The calibration mode must be enabled before the dc source will accept any other calibration commands.

The first parameter specifies the enabled or disabled state. The second parameter is the password. A password is required if calibration mode is being enabled and the existing password is not 0. If the password is not entered or is incorrect, an error is generated and the calibration mode remains disabled. The query returns only the state, not the password.

NOTE: Whenever the calibration state is changed from enabled to disabled, any new calibration constants are lost unless they have been stored with CALibrate:SAVE.

Command Syntax	CALibrate:STATE <bool>[,<NRf>]
Parameters	0 OFF 1 ON [,<password>]
*RST Value	OFF
Examples	CAL:STAT 1,3280 CAL:STAT OFF
Query Syntax	CALibrate:STATE?
Returned Parameters	<NR1>
Related Commands	CAL:PASS CAL:SAVE *RST

CALibrate:VOLTage

This command initiates the calibration of the output voltage and the voltage measurement circuit.

Command Syntax	CALibrate:VOLTage (@<channel>)
Parameters	None
Examples	CAL:VOLT (@1)

Measurement Commands

Measurement commands consist of fetch, measure, and sense commands.

Measure commands measure the output voltage or current. Measurements are performed by digitizing the instantaneous output voltage or current for a specified number of samples, storing the results in a buffer, and calculating the measured result. Two types of measurement commands are available: MEASure and FETCh. MEASure commands trigger the acquisition of new data before returning the reading. Measurement overflows return a reading of 9.91E+37. FETCh commands return a reading computed from previously acquired data. If you take a voltage measurement, you can fetch only voltage data. If you take a current measurement, you can fetch only current data.

- ◆ Use MEASure when the measurement does not need to be synchronized with any other event.
- ◆ Use FETCh when it is important that the measurement be synchronized with either a trigger or with a particular part of the output waveform.

Sense commands control the current measurement range, the bandwidth detector of the dc source, and the data acquisition sequence.

FETCh:ARRAy:CURRent? FETCh:ARRAy:VOLTage?

These queries return an array containing either the digitized output current in amperes or output voltage in volts. The data returned is the result of the last measurement command or acquisition trigger. The data is valid until the next *RST, MEASure, or INITiate command occurs.

Query Syntax	FETCh:ARRAy:CURRent[:DC]? (@<channel list>)
	FETCh:ARRAy:VOLTage[:DC]? (@<channel list>)
Parameters	None
Examples	FETC:ARR:CURR? (@1) FETC:ARR:VOLT? (@1)
Returned Parameters	<NR3> [,<NR3>]
Related Commands	SENS:SWE:TINT SENS:SWE:OFFS SENS:SWE:POIN

FETCh:CURRent? FETCh:VOLTage?

These queries return either the dc output current in amperes or output voltage in volts. The data returned is the result of the last measurement command or acquisition trigger. The data is valid until the next *RST, MEASure, or INITiate command occurs.

Query Syntax	MEASure[:SCALAr]:CURRent[:DC]? (@<channel list>)
	FETCh[:SCALAr]:CURRent[:DC]? (@<channel list>)
Parameters	None
Examples	MEAS:CURR? (@1) FETC:CURR:DC? (@1)
Returned Parameters	<NR3> [,<NR3>]
Related Commands	MEAS:VOLT? MEAS:CURR?

MEASure:ARRay:CURRent? MEASure:ARRay:VOLTagE?

These queries initiate and trigger a measurement and return an array containing either the digitized output current in amperes or output voltage in volts. The output voltage or current is digitized whenever a measurement command is sent or an acquisition trigger occurs. The time interval is set by SENSE:SWEep:TINTerval. The position of the trigger relative to the beginning of the data buffer is determined by SENSE:SWEep:OFFSet. The number of points returned is set by SENSE:SWEep:POINts.

NOTE: You can specify an optional maximum value parameter. The dc source will select the proper current range to measure the maximum current.

Query Syntax	MEASure:ARRay:CURRent[:DC]? [<maximum value>] (@<channel list>)
	MEASure:ARRay:VOLTagE[:DC]? (@<channel list>)
Parameters	None
Examples	MEAS:ARR:CURR? 0.1, (@1) MEAS:ARR:VOLT? (@1)
Returned Parameters	<NR3>[,<NR3>]
Related Commands	SENS:SWE:TINT SENS:SWE:OFFS SENS:SWE:POIN

MEASure:CURRent? MEASure:VOLTagE?

These queries initiate and trigger a measurement and return either the output current in amperes or output voltage in volts. The total measurement time is specified by SENSE:SWEep:NPLCycles.

NOTE: You can specify an optional maximum value parameter. This lets you use a different current range for a single measurement without having to change current ranges.

Query Syntax	MEASure[:SCALar]:CURRent[:DC]? [<maximum value>] (@<channel list>)
	MEASure[:SCALar]:VOLTagE[:DC]? (@<channel list>)
Parameters	None
Examples	MEAS:CURR? 0.1, (@1) MEAS:VOLT? (@1)
Returned Parameters	<NR3> [,<NR3>]
Related Commands	FETC:VOLT? FETC:CURR? SENS:SWE:NPLC

SENSe:CURRent:RANGe

This command selects one of the following dc current measurement ranges based on the value entered:

Range	Value to select range
0.5 A	values greater than 0.015A
15 mA	values greater than 0.0005A up to 0.015A
0.5 mA	values less than and up to 0.0005A

The programmed value must be the maximum current that you expect to measure. Crossover values are 0.5 mA and 15 mA respectively. When queried, the returned value is the maximum dc current that can be measured on the range that is presently set.

Command Syntax	SENSE:CURRENT[:DC]:RANGE[:UPPER] <Nrf>, (@<channel list>)
Parameters	The maximum current that you expect to measure (see table 6-3)
Unit	A (amperes)
*RST Value	0.5 A
Examples	SENS:CURR:RANG 0.4, (@1)
Query Syntax	SENSE:CURRENT:RANGE? (@<channel list>)
Returned Parameters	<NR3>

SENSE:FUNCTION

This command configures the sensing function for triggered measurements. The dc source has two measurement sensors as described below. The query returns the function setting.

CURRENT Senses the output current at the selected output
VOLTage Senses the output voltage at the selected output

Command Syntax	SENSE:FUNCTION <function>, (@<channel list>)
Parameters	"VOLTage" "CURRENT"
*RST Value	VOLT
Examples	SENS:FUNC "VOLT", (@1)
Query Syntax	SENSE:FUNCTION? (@<channel list>)
Returned Parameters	<SRD>

SENSE:SWEEP:NPLCycles

This command specifies the total measurement acquisition time in terms of ac power line cycles. It automatically sets the sweep time interval, sweep offset, and sweep points. The values are chosen to sample the maximum number of points possible and to provide the best noise filtering.

Command Syntax	SENSE:SWEEP:NPLCycles <Nrf+>
Parameters	1 through <n>
*RST Value	0.00912 (for 60Hz line) 0.0076 (for 50Hz line)
Examples	SENS:SWE:NPLC 10
Query Syntax	SENSE:SWEEP:NPLCycles?
Returned Parameters	<NR3>

SENSE:SWEEP:OFFSET:POINTS

This command defines the offset in a data sweep when an acquire trigger is used. Negative values represent data samples taken prior to the trigger. Positive values represent the delay after the trigger occurs but before the samples are acquired.

Command Syntax	SENSE:SWEEP:OFFSET:POINTS <Nrf+>
Parameters	-4095 through 2,000,000,000
*RST Value	0
Examples	SENS:SWE:OFFS:POIN -2047
Query Syntax	SENSE:SWEEP:OFFSET:POINTS?
Returned Parameters	<NR3>
Related Commands	SENS:SWE:TINT SENS:SWE:POIN MEAS:ARR

SENSe:SWEEp:POINts

This command defines the number of points in a measurement.

Command Syntax	SENSe:SWEEp:POINts <NRf+>
Parameters	1 through 4096
*RST Value	5
Examples	SENS:SWE:POIN 1024
Query Syntax	SENSe:SWEEp:POINts?
Returned Parameters	<NR3>
Related Commands	SENS:SWE:TINT SENS:SWE:OFFS MEAS:ARR

SENSe:SWEEp:TINTerval

This command defines the time period between samples. The value that you enter for the time interval will be rounded to the nearest 30.4 microsecond increment.

Command Syntax	SENSe:SWEEp:TINTerval <NRf+>
Parameters	30.4 microseconds through 60800 seconds
*RST Value	30.4 microseconds
Examples	SENS:SWE:TINT 60.8E-6
Query Syntax	SENSe:SWEEp:TINTerval?
Returned Parameters	<NR3>
Related Commands	SENS:SWE:POIN SENS:SWE:OFFS MEAS:ARR

SENSe:WINDow

This command sets the window function that is used in dc measurement calculations. The following functions can be selected:

HANNing A signal conditioning window that reduces errors in dc measurement calculations in the presence of periodic signals such as ac line ripple. The Hanning window multiplies each point in the measurement sample by the function \cos^4 .

RECTangular A window that returns measurement calculations without any signal conditioning.

NOTE: Neither window function alters the instantaneous voltage or current data returned in the measurement array.

Command Syntax	SENSe:WINDow[:TYPE] <type>
Parameters	HANNing RECTangular
*RST Value	RECTangular
Examples	SENS:WIND RECT
Query Syntax	SENSe:WINDow[:TYPE]?
Returned Parameters	<CRD>

Output Commands

Output commands consist of output and source commands.

Output commands enable the output and oscillation functions.

Source commands program the actual output voltage and current settings.

OUTPut

This command enables or disables the dc source output. The state of a disabled output is a condition of zero output voltage and a model-dependent minimum source current (see ***RST**). The output and sense relays are closed when the output is enabled and opened when the output is disabled. The query returns 0 if the output is off, and 1 if the output is on.

Command Syntax	OUTPut[:STATe] <bool>, (@<channel list>)
Parameters	0 OFF 1 ON
*RST Value	OFF
Examples	OUTP ON, (@1 : 4)
Query Syntax	OUTPut[:STATe]? (@<channel list>)
Returned Parameters	<NR1> 0 1

OUTPut:OSCProtect

This command enables or disables the oscillation protection on the selected output.

Command Syntax	OUTPut:OSCProtect[:STATe] <bool>, (@<channel list>)
Parameters	0 OFF 1 ON
*RST Value	ON
Examples	OUTP:OSCP ON, (@1 : 4)
Query Syntax	OUTPut:OSCProtect[:STATe]? (@<channel list>)
Returned Parameters	<NR1> 0 1

OUTPut:PROTection:CLEAr

This command clears the latch that disables the output when an overvoltage, overtemperature, or oscillation status condition is detected. All conditions that generate the fault must be removed before the latch can be cleared. The output is then restored to the state it was in before the fault condition occurred.

Command Syntax	OUTPut:PROTection:CLEAr (@<channel list>)
Parameters	None
Examples	OUTP:PROT:CLE (@1 : 4)

[SOURce:]CURRENT[:IMMediate] [SOURce:]CURRENT:TRIGgered

These commands set the immediate and the pending triggered current level of the dc source. They only apply in current priority mode. The immediate level is the output current setting. The pending triggered level is a stored value that is transferred to the output when a trigger occurs. To respond to a trigger, the [SOUR:]CURR:MODE must be set to STEP, and the trigger system must be initiated.

Command Syntax [SOURce:]CURRENT[:LEVel][:IMMediate][:AMPLitude] <Nrf+>, (@<channel list>)
[SOURce:]CURRENT[:LEVel]:TRIGgered[:AMPLitude] <Nrf+>, (@<channel list>)

Parameters see table 6-3

Default Suffix A (amperes)

***RST Value** 0

Examples CURR 0.0001 , (@1) CURR:TRIG 0.0002 , (@1)

Query Syntax [SOURce:]CURRENT[:LEVel][:IMMediate][:AMPLitude]? (@<channel list>)
[SOURce:]CURRENT[:LEVel]:TRIGgered[:AMPLitude]? (@<channel list>)

Returned Parameters <NR3>

Related Commands INIT CURR:MODE

[SOURce:]CURRENT:LIMit[:IMMediate] [SOURce:]CURRENT:LIMit:TRIGgered

These commands set the immediate and the pending triggered current limit of the dc source. They only apply in voltage priority mode. The current limit setting applies to both the positive and negative current limits. The pending triggered limit is a stored value that applies when a trigger occurs. To respond to a trigger, the [SOUR:]CURR:LIM:MODE must be set to STEP, and the trigger system must be initiated.

Command Syntax [SOURce:]CURRENT:LIMit[:POSitive][:IMMediate] <Nrf+>, (@<channel list>)
[SOURce:]CURRENT:LIMit[POSitive]:TRIGgered <Nrf+>, (@<channel list>)

Parameters see table 6-3

Default Suffix A (amperes)

***RST Value** 0.001

Examples CURR:LIM 0.25 , (@1) CURR:LIM:TRIG 0.35 , (@1)

Query Syntax [SOURce:]CURRENT:LIMit[:POSitive][:IMMediate]? (@<channel list>)
[SOURce:]CURRENT:LIMit[POSitive]:TRIGgered? (@<channel list>)

Returned Parameters <NR3>

Related Commands INIT CURR:LIM:MODE

[SOURce:]CURRENT:MODE [SOURce:]CURRENT:LIMit:MODE

These commands determine what happens to the output current and current limit during a triggered event.

FIXed The output current and output current limit is unaffected when a trigger occurs.

STEP The output current is set by the CURR:TRIG value when a trigger occurs.

The current limit is set by the CURR:LIM:TRIG value when a trigger occurs.

Command Syntax [SOURce:]CURRENT:MODE <mode>, (@<channel list>)
[SOURce:]CURRENT:LIMit:MODE <mode>, (@<channel list>)

Parameters FIXed | STEP

***RST Value** FIXed

Examples CURR:MODE FIX , (@1) CURR:LIM:MODE FIX , (@1)

Query Syntax [SOURce:]CURRENT:MODE? (@<channel list>)
[SOURce:]CURRENT:LIMit:MODE? (@<channel list>)

Returned Parameters <CRD>

[SOURce:]DELAy

This command sets the delay when [SOUR:]DEL:MODE is set to MANUAL. If an output is changed and a subsequent measurement is requested, the measurement will be delayed to allow the output to settle.

Command Syntax [SOURce:]DELAy[:TIME] <Nrf+>, (@<channel list>)
Parameters 0 to 1000 (seconds)
***RST Value** 0
Examples DEL .001, (@1)
Query Syntax [SOURce:]DELAy[:TIME]? (@<channel list>)
Returned Parameters <NR3>

[SOURce:]DELAy:MODE

This command selects the source delay mode.

AUTO The dc source selects an appropriate delay for the present output voltage or current
MANual The delay programmed by [SOURce:] will be used as the delay.

Command Syntax [SOURce:]DELAy:MODE <mode>, (@<channel list>)
Parameters AUTO | MANual
***RST Value** AUTO
Examples DEL:MODE AUTO, (@1)
Query Syntax [SOURce:]DELAy:MODE? (@<channel list>)
Returned Parameters <CRD>

[SOURce:]FUNctIon:MODE

This command configures the output operating mode. Note that if the output is on, changing the output mode will cause the output to cycle OFF, then ON.

VOLTage Configures the output for voltage priority operation
CURRent Configures the output for current priority operation

Command Syntax [SOURce:]FUNctIon:MODE <mode>, (@<channel list>)
Parameters VOLTage | CURRent
***RST Value** VOLT
Examples FUNC:MODE VOLT, (@1)
Query Syntax [SOURce:]FUNctIon:MODE? (@<channel list>)
Returned Parameters <CRD>

[SOURce:]VOLTage:ALC:BWIDth

This command configures the output compensation band for the voltage mode. If capacitive loads cause the output to oscillate, use this command to select a lower compensation band. Note that if the output is on, changing the compensation will cause the output to cycle OFF, then ON. The following compensation bandwidths may be programmed: 30 kHz, 20 kHz, or 10 kHz.

Command Syntax [SOURce:]VOLTage:ALC:BWIDth <Nrf>, (@<channel list>)
Parameters 10000 | 20000 | 30000
***RST Value** 30000
Examples VOLT:ALC:BWID 10000, (@1)
Query Syntax [SOURce:]VOLTage:ALC:BWIDth? (@<channel list>)
Returned Parameters <NR3>

[SOURce:]VOLTage[:IMMEDIATE] [SOURce:]VOLTage:TRIGgered

These commands set the immediate and the pending triggered voltage level of the dc source. The immediate level is the voltage programmed for the output terminals. The pending triggered level is a stored value that is transferred to the output terminals when a trigger occurs. To respond to a trigger, the [SOUR:]VOLT:MODE must be set to STEP, and the trigger system must be initiated.

Command Syntax	[SOURce:]VOLTage[:LEVel][:IMMEDIATE][:AMPLitude]<Nrf+>, (@<channel list>) [SOURce:]VOLTage[:LEVel]:TRIGgered[:AMPLitude] <Nrf+>, (@<channel list>)
Parameters	see table 6-3
Default Suffix	V (volts)
*RST Value	0
Examples	VOLT 2.5, (@1) VOLT:TRIG 20, (@1)
Query Syntax	[SOURce:]VOLTage[:LEVel][:IMMEDIATE][:AMPLitude]? (@<channel list>) [SOURce:]VOLTage[:LEVel]:TRIGgered[:AMPLitude]? (@<channel list>)
Returned Parameters	<NR3>
Related Commands	INIT VOLT:MODE

[SOURce:]VOLTage:MODE

This command determines what happens to the output voltage during a triggered event.

FIXed	The output voltage is unaffected when a trigger occurs.
STEP	The output voltage is programmed to the value set by VOLT:TRIG when a trigger occurs.

Command Syntax	[SOURce:]VOLTage:MODE <mode>, (@<channel list>)
Parameters	FIXed STEP
*RST Value	FIXed
Examples	VOLT:MODE FIX, (@1)
Query Syntax	[SOURce:]VOLTage:MODE? (@<channel list>)
Returned Parameters	<CRD>
Related Commands	VOLT:TRIG

[SOURce:]VOLTage:PROTection:STATE

This command enables or disables the overvoltage protection (OVP) function. The command only applies in voltage priority mode. When enabled, the output of the unit will shut down and the output relays will open when the output voltage exceeds +11.5V ($\pm 0.3V$), or -11.5V ($\pm 0.3V$).

CAUTION: Disabling the overvoltage protection function may cause excessive output voltages, such as can occur if remote sense leads are shorted, to damage the equipment under test.

Command Syntax	[SOURce:]VOLTage:PROTection:STATe <bool>, (@<channel list>)
Parameters	0 OFF 1 ON
*RST Value	ON
Examples	VOLT:PROT:STAT 0, (@1)
Query Syntax	[SOURce:]VOLTage:PROTection:STATe? (@<channel list>)
Returned Parameters	<NR1>0 or 1

Status Commands

Status commands program the dc source status registers. The dc source has three groups of status registers; Operation, Questionable, and Standard Event. The Standard Event group is programmed with Common commands as described later in this section. The Operation and Questionable status groups each consist of the Condition, Enable, and Event registers and the NTR and PTR filters. Chapter 5 explains how to read specific register bits and use the information they return.

STATus:OPERation[:EVENT]?

This query returns the value of the Operation Event register. The Event register is a read-only register, which stores (latches) all events that are passed by the Operation NTR and/or PTR filter. Reading the Operation Event register clears it.

Query Syntax	STATus:OPERtion[:EVENT]? (@<channel list>)
Parameters	None
Returned Parameters	<NR1>(register value)
Examples	STAT:OPER? (@1)
Related Commands	*CLS STAT:OPER:NTR STAT:OPER:PTR

Table 6-4. Bit Configuration of Operation Status Registers

Bit Position	6	5	4	3	2	1	0
Bit Name	OFF	VL-	VL+	CC	CL-	CL+	CV
Bit Value	64	32	16	8	4	2	1
OFF =The selected output is off				CL- =The selected output is in negative current limit ²			
VL- =The selected output is in negative voltage limit ¹				CL+ =The selected output is in positive current limit ²			
VL+ =The selected output is in positive voltage limit ¹				CV =The selected output is in constant voltage ²			
CC =The selected output is in constant current ¹				¹ Current priority mode only. ² Voltage priority mode only.			

STATus:OPERation:CONDition?

This query returns the value of the Operation Condition register. That is a read-only register, which holds the live (unlatched) operational status of the dc source.

Query Syntax	STATus:OPERation:CONDition? (@<channel list>)
Parameters	None
Examples	STAT:OPER:COND? (@1) STATUS:OPERATION:CONDITION? (@1)
Returned Parameters	<NR1> (register value)

STATus:OPERation:ENABLE

This command and its query set and read the value of the Operational Enable register. This register is a mask for enabling specific bits from the Operation Event register to set the operation summary bit (OPER) of the Status Byte register. This bit (bit 7) is the logical OR of all the Operatonal Event register bits that are enabled by the Status Operation Enable register.

Command Syntax	STATus:OPERation:ENABLE<NRf>,@<channel list>
Parameters	0 to 32767
Preset Value	0
Examples	STAT:OPER:ENAB 1312, (@1)
Query Syntax	STATus:OPERation:ENABLE? (@<channel list>)
Returned Parameters	<NR1> (register value)
Related Commands	STAT:OPER?

STATus:OPERation:NTR

STATus:OPERation:PTR

These commands set or read the value of the Operation NTR (Negative-Transition) and PTR (Positive-Transition) registers. These registers serve as polarity filters between the Operation Enable and Operation Event registers to cause the following actions:

- ◆ When a bit in the Operation NTR register is set to 1, then a 1-to-0 transition of the corresponding bit in the Operation Condition register causes that bit in the Operation Event register to be set.
- ◆ When a bit of the Operation PTR register is set to 1, then a 0-to-1 transition of the corresponding bit in the Operation Condition register causes that bit in the Operation Event register to be set.
- ◆ If the same bits in both NTR and PTR registers are set to 1, then any transition of that bit at the Operation Condition register sets the corresponding bit in the Operation Event register.
- ◆ If the same bits in both NTR and PTR registers are set to 0, then no transition of that bit at the Operation Condition register can set the corresponding bit in the Operation Event register.

Command Syntax STATus:OPERtion:NTRansition<NRf>, (@<channel list>)
 STATus:OPERtion:PTRansition<NRf>, (@<channel list>)

Parameters 0 to 32767

Preset Value NTR register = 0; PTR register = 32767

Examples STAT:OPER:NTR 32, (@1) STAT:OPER:PTR 1312, (@1)

Query Syntax STAT:OPER:NTR? (@<channel list>)
 STAT:OPER:PTR? (@<channel list>)

Returned Parameters <NR1> (register value)

STATus:PRESet

This command sets all defined bits in the Status Subsystem PTR registers and clears all bits in the subsystem NTR and Enable registers.

Command Syntax STATus:PRESet

Parameters None

Examples STAT:PRES STATUS:PRESET

STATus:QUESTionable[:EVENT]?

This query returns the value of the Questionable Event register. The Event register is a read-only register that stores (latches) all events that are passed by the Questionable NTR and/or PTR filter. Reading the Questionable Event register clears it.

Query Syntax STATus:QUESTionable[:EVENT]? (@<channel list>)

Parameters None

Examples STAT:QUES? (@1)

Returned Parameters <NR1> (register value)

Related Commands *CLS STAT:QUES:ENAB STAT:QUES:NTR STAT:QUES:PTR

Table 6-5. Bit Configuration of Questionable Status Registers

Bit Position	15	14	13	12	11	10	9-5	4	3	2	1	0
Bit Name	not used	Meas Ovld	not used	OSC	not used	UNR	not used	OT	not used	PCLR	OV-	OV+
Bit Value		16384		4096		1024		16			2	1
Meas Ovld = The output measurement exceeded the capability of the range						OT = The overtemperature protection has tripped						
OSC = The oscillation protection has tripped						PCLR = No communication with the selected output						
UNR = The output is unregulated						OV- = The negative overvoltage protection has tripped						
						OV+ = The positive overvoltage protection has tripped						

STATus:QUEStionable:CONDition?

This query returns the value of the Questionable Condition register. That is a read-only register, which holds the real-time (unlatched) questionable status of the dc source.

Query Syntax	STATus:QUEStionable:CONDition? (@<channel list>)
Parameters	None
Examples	STAT:QUES:COND? (@1)
Returned Parameters	<NR1> (register value)

STATus:QUEStionable:ENABLE

This command and its query set and read the value of the Questionable Enable register. This register is a mask for enabling specific bits from the Questionable Event register to set the questionable summary bit (QUES) of the Status Byte register. This bit (bit 3) is the logical OR of all the Questionable Event register bits that are enabled by the Questionable Status Enable register..

Command Syntax	STATus:QUEStionable:ENABLE<NRf>, (@<channel list>)
Parameters	0 to 32767
Preset Value	0
Examples	STAT:QUES:ENAB 4096, (@1) !enables OSC
Query Syntax	STATus:QUEStionable:ENABLE? (@<channel list>)
Returned Parameters	<NR1> (register value)
Related Commands	STAT:QUES?

STATus:QUEStionable:NTR**STATus:QUEStionable:PTR**

These commands allow you to set or read the value of the Questionable NTR (Negative-Transition) and PTR (Positive-Transition) registers. These registers serve as polarity filters between the Questionable Enable and Questionable Event registers to cause the following actions:

- ◆ When a bit of the Questionable NTR register is set to 1, then a 1-to-0 transition of the corresponding bit of the Questionable Condition register causes that bit in the Questionable Event register to be set.
- ◆ When a bit of the Questionable PTR register is set to 1, then a 0-to-1 transition of the corresponding bit in the Questionable Condition register causes that bit in the Questionable Event register to be set.
- ◆ If the same bits in both NTR and PTR registers are set to 1, then any transition of that bit at the Questionable Condition register sets the corresponding bit in the Questionable Event register.
- ◆ If the same bits in both NTR and PTR registers are set to 0, then no transition of that bit at the Questionable Condition register can set the corresponding bit in the Questionable Event register.

Command Syntax	STATus:QUEStionable:NTRansition<NRf>, (@<channel list>) STATus:QUEStionable:PTRansition<NRf>, (@<channel list>)
Parameters	0 to 32767
Preset Value	NTR register = 0; PTR register = 32767
Examples	STAT:QUES:NTR 16, (@1) STAT:QUES:PTR 512, (@1)
Query Syntax	STAT:QUES:NTR? (@<channel list>) STAT:QUES:PTR? (@<channel list>)
Returned Parameters	<NR1>(Register value)
Related Commands	STAT:QUES:ENAB

System Commands

System commands control system functions that are not directly related to output control or measurement functions.

SYSTem:ERRor?

This query returns the next error number followed by its corresponding error message string from the remote programming error queue. The queue is a FIFO (first-in, first-out) buffer that stores errors as they occur. As it is read, each error is removed from the queue. When all errors have been read, the query returns 0,NO ERROR. If more errors are accumulated than the queue can hold, the last error in the queue will be -350,TOO MANY ERRORS (see Appendix C for other error codes).

Query Syntax	SYSTem:ERRor?
Parameters	None
Returned Parameters	<NR1> , <SRD>
Examples	SYST:ERR?

SYSTem:VERSion?

This query returns the SCPI version number to which the instrument complies. The returned value is of the form YYYY.V, where YYYY represents the year and V is the revision number for that year.

Query Syntax	SYSTem:VERSion?
Parameters	None
Returned Parameters	<NR2>
Examples	SYST:VERS?

Trigger Commands

Trigger commands consist of trigger and initiate commands.

Initiate commands initialize the trigger system.

Trigger commands control the remote triggering of the dc source. They are used to generate output and measurement triggers.

NOTE: Before you generate a measurement trigger, you must specify either a voltage or current measurement acquisition using the SENSE:FUNCTION command.

ABORt

This command cancels any trigger actions presently in process. Pending trigger levels are reset to their corresponding immediate values. ABORt also resets the WTG bit in the status byte (see chapter 5 about programming the status registers). ABORt is executed at power turn on and upon execution of *RST.

Command Syntax	ABORt
Parameters	None
Examples	ABOR
Related Commands	INIT *RST *TRG TRIG

INITiate:NAME

This command controls the enabling of both output and measurement triggers. When a trigger is enabled, an event on a selected trigger source causes the specified triggering action to occur. If the trigger system is not enabled, all triggers are ignored.

Command Syntax	INITiate[:IMMEDIATE]:NAME <name>
Parameters	TRANSient ACQUIRE
Examples	INIT:NAME TRAN
Related Commands	ABOR INIT:CONT TRIG *TRG

TRIGger:ACQUIRE

This command generates a measurement trigger. When the trigger system is initiated, the measurement trigger causes the dc source to measure either the output voltage or current and store the results in a buffer. The SENSE:FUNC command determines which signal will be measured.

Command Syntax	TRIGger:ACQUIRE[:IMMEDIATE]
Parameters	None
Examples	TRIG TRIG:IMM
Related Commands	ABOR INIT *TRG SENSE:FUNC

TRIGger:ACQuire:SOURce

This command selects the trigger source for the measurement trigger system.

EXT External trigger input signal
BUS GPIB device, *TRG, or <GET> (Group Execute Trigger)

Command Syntax TRIGger:ACQuire:SOURce <source>
Parameters BUS | EXTErnal
***RST Value** BUS
Examples TRIG:ACQ:SOUR EXT
Query Syntax TRIGger:ACQuire:SOURce?
Returned Parameters <CRD>

TRIGger[:TRANsient]:SOURce

This command selects the trigger source for the output trigger system.

EXTErnal External trigger input signal
BUS GPIB device, *TRG, or <GET> (Group Execute Trigger)

Command Syntax TRIGger[:TRANsient]:SOURce <source>
Parameters BUS | EXTErnal
***RST Value** BUS
Examples TRIG:SOUR EXT
Query Syntax TRIGger[:TRANsient]:SOURce?
Returned Parameters <CRD>

TRIGger[:TRANsient]

This command generates an output trigger. Output triggers affect the following functions: voltage, current, and current limit. To program an output trigger you must specify a trigger level for the selected function, set the selected function to STEP mode, and initiate the trigger system.

Once these conditions are met, the output trigger will:

1. Initiate a pending level change as specified by [SOURce;]CURRent:TRIGgered, [SOURce;]CURRent:LIMit:TRIGgered, or [SOURce;]VOLTag:e:TRIGgered.
2. Clear the WTG bit in the Status Operation Condition register after both transient and acquire trigger sequences have completed. (WTG is the logical-or of both transient and acquire sequences.)

Command Syntax TRIGger[:TRANsient][:IMMEDIATE]
Parameters None
Examples TRIG TRIG:IMM
Related Commands ABOR INIT *TRG VOLT:TRIG CURR:TRIG
CURR:LIM:TRIG CURR:MODE CURR:LIM:MODE
VOLT:MODE

Common Commands

*CLS

This command causes the following actions (see chapter 5 for the descriptions of all registers):

- ◆ Clears the Standard Event Status, Operation Status Event, and Questionable Status Event registers
- ◆ Clears the Status Byte and the Error Queue
- ◆ If *CLS immediately follows a program message terminator (<NL>), then the output queue and the MAV bit are also cleared.

Command Syntax *CLS
Parameters None

*ESE

This command programs the Standard Event Status Enable register bits. The programming determines which events of the Standard Event Status Event register (see *ESR?) are allowed to set the ESB (Event Summary Bit) of the Status Byte register. A "1" in the bit position enables the corresponding event. All of the enabled events of the Standard Event Status Event Register are logically ORed to cause the Event Summary Bit (ESB) of the Status Byte Register to be set. The query reads the Standard Event The query reads the Standard Event Status Enable register.

Table 6-6. Bit Configuration of Standard Event Status Enable Register

Bit Position	7	6	5	4	3	2	1	0
Bit Name	PON	0	CME	EXE	DDE	QUE	0	OPC
Bit Weight	128	64	32	16	8	4	2	1
PON = Power-on has occurred CME = Command error EXE = Execution error					DDE = Device-dependent error QUE = Query error OPC = Operation complete			

Command Syntax *ESE <NRf>
Parameters 0 to 255
Power-On Value 0
Examples *ESE 129
Query Syntax *ESE?
Returned Parameters <NR1> (register value)
Related Commands *ESR? *PSC *STB?

*ESR?

This query reads the Standard Event Status Event register. Reading the register clears it. The bit configuration is the same as the Standard Event Status Enable register (see *ESE).

Query Syntax *ESR?
Parameters None
Returned Parameters <NR1> (register binary value)
Related Commands *CLS *ESE *ESE? *OPC

***IDN?**

This query requests the dc source to identify itself. It returns a string composed of four fields separated by commas.

Query Syntax	*IDN?	Field	Information
Returned Parameters	<AARD>	Agilent Technologies xxxxxA 0 <A>.xx.xx	Manufacturer model number followed by a letter suffix zero or the unit's serial number if available Revision levels of firmware.
Example	AGILENT TECHNOLOGIES , N3280A , 0 , A . 00 . 01		

***OPC**

This command causes the instrument to set the OPC bit (bit 0) of the Standard Event Status register when the dc source has completed all pending operations. (See *ESE for the bit configuration of the Standard Event Status register.) *Pending operations* are complete when:

- ◆ all commands sent before *OPC have been executed. This includes overlapped commands. Most commands are sequential and are completed before the next command is executed. Overlapped commands are executed in parallel with other commands. Commands that affect output voltage, current or state, relays, and trigger actions are overlapped with subsequent commands sent to the dc source. The *OPC command provides notification that all overlapped commands have been completed.
- ◆ all triggered actions are completed

*OPC does not prevent processing of subsequent commands, but bit 0 will not be set until all pending operations are completed.

*OPC? causes the instrument to place an ASCII "1" in the Output Queue when all pending operations are completed. Unlike *OPC, *OPC? prevents processing of all subsequent commands. It is intended to be used at the end of a command line so that the application program can then monitor the bus for data until it receives the "1" from the dc source Output Queue.

Command Syntax	*OPC
Parameters	None
Query Syntax	*OPC?
Returned Parameters	<NR1> 1
Related Commands	*OPC *TRIG *WAI

***OPT?**

This query requests the dc source to identify any options that are installed. Options are identified by number. A 0 indicates no options are installed.

Query Syntax	*OPT?
Returned Parameters	<AARD>

***RST**

This command resets the dc source to a factory-defined state as defined in the following table. *RST also forces an ABORT command.

Table 6-7. *RST Settings

CAL:STAT	OFF	[SOUR:]CURR:LIM	1E-3
OUTP	OFF	[SOUR:]CURR:LIM:TRIG	1E-3
OUTP:OSCP	ON	[SOUR:]CURR:LIM:MODE	FIXed
SENS:CURR:RANG	.5	[SOUR:]FUNC:MODE	VOLT
SENS:FUNC	VOLT	[SOUR:]DEL	0
SENS:SWE:NPLC	.00912 (60 Hz);	[SOUR:]DEL:MODE	AUTO
	.0076 (50 Hz)	[SOUR:]VOLT:ALC:BWID	30000
SENS:SWE:POIN	5	[SOUR:]VOLT	0
SENS:SWE:OFFS:POIN	0	[SOUR:]VOLT:TRIG	0
SENS:SWE:TINT	30.4E-6	[SOUR:]VOLT:MODE	FIXed
SENS:WIND	RECTangular	[SOUR:]VOLT:PROT:STAT	ON
[SOUR:]CURR	0	TRIG:ACQ:SOUR	BUS
[SOUR:]CURR:TRIG	0	TRIG:SOUR	BUS
[SOUR:]CURR:MODE	FIXed		

Command Syntax *RST
Parameters None

***SRE**

This command sets the condition of the Service Request Enable Register. This register determines which bits from the Status Byte Register (see *STB for its bit configuration) are allowed to set the Master Status Summary (MSS) bit and the Request for Service (RQS) summary bit. A 1 in any Service Request Enable Register bit position enables the corresponding Status Byte Register bit and all such enabled bits then are logically ORed to cause Bit 6 of the Status Byte Register to be set.

When the controller conducts a serial poll in response to SRQ, the RQS bit is cleared, but the MSS bit is not. When *SRE is cleared (by programming it with 0), the dc source cannot generate an SRQ to the controller. The query returns the current state of *SRE.

Command Syntax *SRE <NRf>
Parameters 0 to 255
Power-on Value 0
Example *SRE 20
Query Syntax *SRE?
Returned Parameters <NR1> (register binary value)
Related Commands *ESE *ESR

***STB?**

This query reads the Status Byte register, which contains the status summary bits and the Output Queue MAV bit. Reading the Status Byte register does not clear it. The input summary bits are cleared when the appropriate event registers are read. The MAV bit is cleared at power-on, by *CLS' or when there is no more response data available.

A serial poll also returns the value of the Status Byte register, except that bit 6 returns Request for Service (RQS) instead of Master Status Summary (MSS). A serial poll clears RQS, but not MSS. When MSS is set, it indicates that the dc source has one or more reasons for requesting service.

Table 6-8. Bit Configuration of Status Byte Register

Bit Position	7	6	5	4	3	2	1	0
Bit Name	OPER	MSS (RQS)	ESB	MAV	QUES	WTG	0	0
Bit Value	128	64	32	16	8	4	2	1
OPER = Operation status summary MSS = Master status summary (RQS) = Request for service ESB = Event status byte summary				MAV = Message available QUES = Questionable status summary WAI = Waiting for a trigger				

Query Syntax *STB?
Returned Parameters <NR1> (register binary value)

***TRG**

This common command generates a trigger when the trigger subsystem has BUS selected as its source. The command has the same affect as the Group Execute Trigger (<GET>) command.

Command Syntax *TRG
Parameters None
Related Commands ABOR INIT TRIG[:IMM] <GET>

***TST?**

This query causes the dc source to do a self-test and report any errors. 0 indicates that the dc source passed self-test. 1 indicates that one or more tests failed. Selftest errors are written to the error queue (see Appendix C).

Query Syntax TST?
Returned Parameters <NR1>

***WAI**

This command instructs the dc source not to process any further commands until all pending operations are completed. "Pending operations" are as defined under the *OPC command. *WAI can be aborted only by sending the dc source an GPIB DCL (Device Clear) command.

Command Syntax *WAI
Parameters None
Related Commands *OPC* OPC?

Specifications

Introduction

Table A-1 lists the specifications of the dc source. Unless otherwise noted, specifications are warranted at $25^{\circ}\text{C} \pm 5^{\circ}\text{C}$ after a 30-minute warm-up period. Sense terminals must be connected to their respective output terminals.

Table A-1. Specifications

Parameter	Voltage Priority	Current Priority
Output Ratings (refer to derating characteristic)	Voltage: -10.25V to +10.25V	-8V to +8V (min. with full resistive load) -11.25V to +11.25V (max. with no load)
	Current: -0.5125A to +0.5125A	-0.5125 mA to +0.5125 mA
Programming Accuracy	Voltage	0.1%±2mV
	+ Current Limit:	0.1%±50µA
	- Current Limit:	0.1%±50µA
	Current:	N/A
Readback Accuracy ¹	Voltage:	0.1%±2mV (5 points)
	0.5A Curr. Range:	0.1%±200µA (5 points)
	15mA Curr. Range:	0.1%±5µA (5 points)
	0.5mA Curr. Range:	0.1%±200nA (1 PLC)
Ripple and Noise (In the range of 20 Hz to 20 MHz)	Voltage (rms) ² :	0.380mV
	Voltage (p-p) ² :	4mV
	±Current Limit (rms) ³ :	40µA
	Current (rms) ⁴ :	N/A
Load Effect (Change from no load to full load or full load to no load by varying a resistive load)	Voltage:	±400µV
	+ Current Limit:	±30µA
	- Current Limit:	±30µA
	Current:	N/A
Source Effect (change in output voltage or current for any line change within ratings)	Voltage:	±200µV
	+ Current Limit:	±10µA
	- Current Limit:	±10µA
	Current:	N/A
Output Transient Response	Voltage (@ 10kHz) ⁵ :	60µs
	(@ 20kHz):	45µs
	(@ 30kHz):	35µs
	Current ⁶ :	N/A

¹ Voltage accuracy specification in voltage priority mode guaranteed between -10.25V to +10.25V. 0.5A current range accuracy specification in voltage priority mode guaranteed between -0.5125A and +0.5125A. Readback for Voltage, 0.5A, and 15mA current ranges is based on capturing 5 data points at intervals of 30.4µs and averaging the readings. Readback for 0.5mA current range is based on averaging the readings over 1 power line cycle (60 Hz = 548 points @ 30.4µs). The default setting for all readback ranges is the average of 5 data points 30.4µs apart.

² Program Vset to ±10V using a 20 ohm load resistor.

³ Program current to +500mA using a 20 ohm load resistor. Program Vset to ±10.25V.

⁴ Program current to ±0.5mA using a 16K ohm load resistor.

⁵ Measured with a 10uF output capacitor with 0.2 ohm ESR across the output with the current limit set to +0.5125A. The load current rise time is approximately 10us for a current change of 0.25A to 0.5A or 0.5A to 0.25A. Measure the output voltage recovery time to within 40mV of its final value.

⁶ Measured following a voltage change of -1V to +1V or +1V to -1V with approximately 25us time constant with the current priority current level set to 0uA. Measure the output current recovery time to within ±1mA of its final value.

A - Specifications

Table A-2 lists the supplemental characteristics, which are not warranted but are descriptions of typical performance determined either by design or type testing.

Table A-2 Supplemental Characteristics

Parameter		Voltage Priority	Current Priority
Output Programming Limits	Voltage:	-10.25V to 10.25V	N/A
	+ Current Limit ¹ :	75µA to 0.5125A	N/A
	- Current Limit:	tracks + Current Limit	N/A
	Current:	N/A	- 0.5125mA to +0.5125mA
Programming Resolution	Voltage:	16 bits / 312µV	N/A
	+ Current Limit:	16 bits / 8µA	N/A
	- Current Limit:	16 bits / 8µA	N/A
	Current:	N/A	16 bits / 16 nA
Bandwidth (approximate voltage loop bandwidth with no external capacitor)	Voltage:	10kHz	N/A
		20kHz	N/A
		30kHz	N/A
Typical Output Readback Ranges	Voltage:	-13.25V to +13.25V	-13.25V to +13.25V
	0.5A Curr. Range:	-0.6A to +0.6A	-0.5125mA to +0.5125mA
	15mA Curr. Range:	-15.375mA to +15.375mA	-0.5125mA to +0.5125mA
	0.5mA Curr. Range:	-0.5125mA to +0.5125mA	-0.5125mA to +0.5125mA
Readback Resolution	Voltage:	16 bits / 312µV	16 bits / 312µV
	0.5A Curr. Range:	16 bits / 18µA	16 bits / 16nA
	15mA Curr. Range:	16 bits / 460nA	16 bits / 16nA
	0.5mA Curr. Range:	16 bits / 16nA	16 bits / 16nA
DC Readback speed ² (with no change on the output)	Voltage:	1.3ms (5 points)	
	0.5A Curr. Range:	1.3ms (5 points)	
	15mA Curr. Range:	1.3ms (5 points)	
	0.5mA Curr. Range:	1.3ms (5 points)	
Peak Current Limit (not programmable)		±1.3A (typical)	±5mA (typical)
CV to CL mode crossover ³	Vset = ±5V, Curr. Limit = 0.5125A:	±1A for 200µs (typical)	N/A
	Vset = ±10V, Curr. Limit = 0.1A:	±0.2A for 600µs (typical)	N/A
Voltage Programming Settling Time ⁴	Voltage (to within 20mV@10kHz):	420µs	N/A
	Voltage (to within 20mV@30kHz):	350µs	N/A
Programming Output Rise Time	Voltage ⁵ (10% to 90% @10kHz):	150µs	N/A
	+Curr. Lim ⁶ (10% to 90%):	450µs	N/A
	-Curr. Lim ⁷ (10% to 90%):	450µs	N/A
	Current ⁸ (-80% to +80%):	N/A	160µs
Programming Output Fall Time	Voltage ⁹ (90% to 10% @10kHz):	150µs	N/A
	+Curr Lim ¹⁰ (90% to 10%):	450µs	N/A
	-Curr Lim ¹¹ (90% to 10%):	450µs	N/A
	Current ¹² (-80% to +80%):	N/A	160µs

¹ If current limit is programmed less than 75µA, the current limit will be set to 75µA (no error will be generated).

² Time from the start of bus communication to final byte returned on bus. Assumes the default of 5 data points 30.4µs apart.

³ With any bandwidth setting.

⁴ With a 20 ohm load resistor and current limit set to +0.5125A, program voltage 0V to ±10V. Measure time for voltage to settle within 20mV of final value.

⁵ With 20 ohm load resistor and current limit set to +0.5125A, program voltage from 0V to ±10V.

⁶ With 20 ohm load resistor and voltage set to 10.25V, program current limit from 0A to 0.5A.

⁷ With 20 ohm load resistor and voltage set to -10.25V, program current limit from 0A to 0.5A.

⁸ With 1k load resistor, program current from -0.5mA to +0.5mA. Measure time from -0.4mA to +0.4mA.

⁹ With no load and current limit set to +0.5125A, program voltage from ±10V to 0V.

¹⁰ With 20 ohm load resistor and voltage set to 10.25V, program current limit from 0.5A to 0A.

¹¹ With 20 ohm load resistor and voltage set to -10.25V program current limit from 0.5A to 0A.

¹² With 1k load resistor, program current from +0.5mA to -0.5mA. Measure time from +0.4mA to -0.4mA.

Table A-2 Supplemental Characteristics (continued)

Parameter		Voltage Priority		Current Priority			
Maximum Output Cable Impedance	Lead R:	1Ω		100μH			
	Lead L:	10μH					
Overvoltage Protection ¹³	Positive:	+11.5V ±0.3V		N/A			
	Negative:	-11.5V ±0.3V					
Output Common Mode Current ¹⁴	(shorting either Hi or Low terminal to the chassis)	<2μA rms					
Trigger in		Chassis ground referenced TTL levels.					
Trigger latency		30μs maximum					
GPIB Interface Capabilities		AH1, C0, DC1, DT1, E1, L4, PP0, RL1, SH1, SR1, T6					
Output Derating		Full current to 40° C. Linearly derated to 50% of full current at 55° C.					
Output Disconnect		Accomplished via solid state disconnect relays. Output impedance in open state is approximately 100K					
Altitude Derating	Up to 7500 feet: > 7500 feet up to 15000 feet:	Full current @40° C. Derated by 1.1 degrees C for every additional 1000 feet					
Secondary Isolation	To Chassis:	±50V					
	Output to Output:	±100V					
RFI		Level A					
Safety		UL, CSA, CE					
Regulatory Compliance	Listing pending:	UL 3111-1					
	Certified to:	CSA 22.2 No. 1010.1					
	Conforms to:	IEC 1010-1, EN 61010-1					
	Complies with:	EMC directive 89/336/EEC (ISM group 1 Class A)					
Calibration Interval		1 Year					
Dimensions	Height:	3.5" (88.9 mm)					
	Width:	8 3/8" (212.7 mm)					
	Depth:	19.6" (497.8 mm)					
Weight	Shipping:	26 lbs (11.8 kg)					
	Net:	22 lbs (10 kg)					
Input Voltage Range	Line Fuse	RMS Input Current		Peak Inrush current		Full Load Input Power	
		Typ.	Max.	Typ.	Max.	Typ.	Max.
100 Vac (87-106 Vac):	3.15AT	1.75A	1.85A	56A	60A	130W	140W
120 Vac (104-127 Vac):	3.15AT	1.4A	1.55A	48A	53A	130W	140W
220 Vac (191-233 Vac):	1.6AT	0.8A	0.90A	34A	40A	130W	140W
230 Vac (207-253 Vac):	1.6AT	0.7A	0.80A	32A	36A	130W	140W

¹³ Output is shut down and output relays are opened¹⁴ Measurement taken with ammeter having approx. 1k shunt resistance and 10Hz to 1kHz bandwidth. Input ac is 120V, 60Hz.

Performance Tests and Calibration

Introduction

This appendix contains test procedures to verify that the dc source is operating normally and is within published specifications. There are three types of tests as follows:

Built-in Self Tests	These tests run automatically when the dc source is turned on. They check most of the digital circuits and the programming and readback DACs.
Turn on Checkout	These tests, described in chapter four, provide a high degree of confidence that your unit is operating properly.
Calibration Verification /Performance Tests	These tests, documented in this appendix, verify that the dc source is properly calibrated, and that the dc source meets all of the specifications listed in Appendix A

If the dc source fails any of the tests or if abnormal test results are obtained after performing a calibration, return the unit to an Agilent Technologies repair facility.

This appendix also includes calibration procedures for the Agilent N3280A. Instructions are given for performing the procedures from a controller over the GPIB.

IMPORTANT: Perform the Programming Accuracy and Readback Accuracy tests before calibrating your dc source. If the dc source passes the Programming Accuracy and Readback Accuracy tests, the unit is operating within its calibration limits and does not need to be re-calibrated.

Equipment Required

The equipment listed in the following table, or the equivalent to this equipment, is required for the calibration and performance tests. A test record sheet with specification limits (when test using the recommended test equipment) may be found at the back of this section.

Table B-1. Equipment Required

Type	Specifications	Recommended Model
Digital multimeter	Resolution: 10nV @ 1V; Readout: 8 1/2 digits; Accuracy: 20 ppm	Agilent 3458A or equivalent
Electronic load	20 V, 5A minimum, with transient capability and a slew rate of 0.833A/μs or better.	Agilent N3300A mainframe, with N3303A module 6063A/B
GPIB controller	Full GPIB capabilities (only required if you are calibrating the unit over the GPIB)	HP Series 200/300 or PC with GPIB capability

B - Performance and Calibration Procedures

Table B-1. Equipment Required (continued)

Oscilloscope	Sensitivity: 1 mV/div. Bandwidth Limit: 20 to 30 MHz Probe: 1:1 with RF tip	Agilent Infinium or equivalent
RMS voltmeter	True RMS Bandwidth: 20 Mhz min. Sensitivity: 100 μ V	Rhode & Schwartz Model URE3 RMS-P-P Voltmeter
Variable-voltage transformer or ac source	Adjustable to highest rated input voltage range. Power: 500 VA	Agilent 6800 series
Tektronix current probe amplifier and power module	20mA/div	AM503B TM501 or 2A
Pulse/function generator	+/- 1V Square Wave , 400-1kHz	Agilent 8116A
Load resistor, 20 ohms	20 ohm 10W	0811-3896 or equivalent
Resistor 0.2 ohm	5- 1 ohm resistors in parallel	5 – 0699-0208 or equivalent
Resistor 1k ohm	1k ohm for 15mA range accuracy	0757-0280 or equivalent
Resistor 20K ohm	20k ohm for 0.5mA range accuracy	0757-0449 or equivalent
Resistor 16k ohm	16.2k ohm for rms noise measurements	0757-0447 or equivalent
Resistor 50 ohm	50 ohm series resistor for noise measurements	0757-0706 or equivalent
Capacitor 10uF for voltage transient response	3- 3.3uF film type capacitors in parallel	3 – 0160-7308 or equivalent
Capacitor for current transient response	0.47uF film type capacitor	1060-0970 or equivalent

Performance & Verification Tests

Enter all of the performance test results and calculated measurements in the Performance Test Record Form that is provided at the end of this section.

Measurement Techniques

If more than one meter or if a meter and an oscilloscope are used, connect each to the terminals by a separate pair of leads to avoid mutual coupling effects. For constant voltage dc tests, connect only to HI sense and LO sense terminals, since the unit regulates the voltage that appears at the sense terminals, not the output terminals. Use twisted-pair wiring to avoid noise pickup on the test leads.

NOTE: When using the Agilent 3458A as an ammeter, always select the specific current measurement range that you will be using. Do not use the autoranging feature of the ammeter, as this may introduce noise in your current measurements by toggling between measurement ranges. Always use the lowest range possible to provide the best measurement accuracy.

Electronic Load

Many of the test procedures require the use of a variable load capable of dissipating the required power. For most tests, an electronic load is considerably easier to use than load resistors, but it may not be fast enough to test transient recovery time and may be **too noisy** for the noise (PARD) tests.

NOTE: When using an electronic load with a bi-polar dc source, be sure to reverse the polarity of the load connections to match the appropriate polarity.

Fixed load resistors may be used in place of a variable load, with minor changes to the test procedures. If resistors are used, switches should also be used to connect, disconnect, or short the load resistors.

Programming

You can only program the dc source from a GPIB controller when performing the tests. The test procedures are written assuming that you know how to program the dc source remotely from an GPIB controller. Also, when performing the verification tests from a GPIB controller, you may have to consider the relatively slow settling times and slew rates of the dc source as compared to computer and system voltmeters. Suitable WAIT statements can be inserted into the test program to give the dc source time to respond to the test commands.

Test Setup

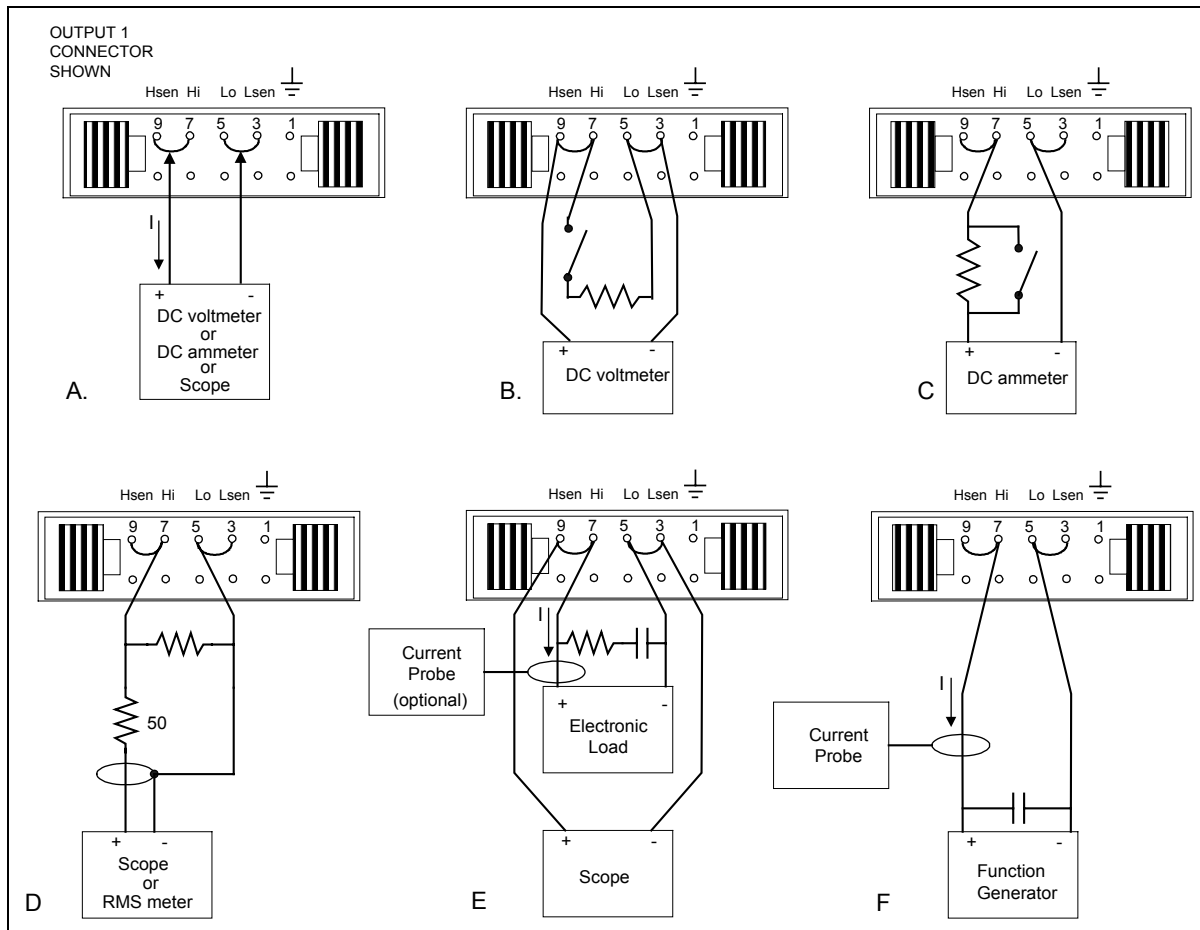

Figure B-1. Verification and Calibration Test Setup

Voltage Priority Tests

Voltage Programming and Readback Accuracy

These tests verify that the voltage programming and GPIB readback functions are within specifications.

Action	Program Commands
1. Reset the dc source and connect a DVM as shown in Figure B-1a. Connect the DVM directly across the HI and LO sense terminals. (*RST resets the dc source to its default settings with the output off.)	"*RST"
2. Turn on the dc source and program the current limit to 0.5125A. Measure the output voltage and current.	"OUTP ON, (@1) " "CURR:LIM 0.5125, (@1) " "MEAS:VOLT? (@1) " "MEAS:CURR? (@1) "
3. Set the DVM to the 10V range, and record the output voltage reading. The DVM reading and measurement query result should be within the limits specified in the performance test record card under Voltage Priority Programming Accuracy @0V and Readback Accuracy @0V. (The current measurement query result should be approximately zero.)	
4. Program the output voltage to full-scale positive output. Measure the output voltage.	"VOLT 10, (@1) " "MEAS:VOLT? (@1) "
5. Record the output voltage reading on the DVM. The DVM reading should be within the limits specified in the test record card under Voltage Priority Programming Accuracy @ +10V. The <i>difference</i> between the DVM reading and the measurement query result should be within the limits specified under Readback Accuracy @ +10V.	
6. Program the output voltage to full-scale negative output. Measure the output voltage.	"VOLT -10, (@1) " "MEAS:VOLT? (@1) "
7. Record the output voltage reading on the DVM. The DVM reading should be within the limits specified in the test record card under Voltage Priority Programming Accuracy @ -10V. The <i>difference</i> between the DVM reading and the measurement query result should be within the limits specified under Readback Accuracy @ -10V.	

Positive Current Limit (+CL)

Action	Program Commands
1. Reset the dc source and connect an ammeter directly across the HI and LO terminals as shown in Figure B-1a. (*RST resets the dc source to its default settings with the output off.)	"*RST"
2. Turn on the dc source and program the output voltage to 10 volts. (The default output current limit is set to 1mA.)	"OUTP ON, (@1) " "VOLT 10, (@1) "
3. Set the ammeter to the 1mA range, and record the output current reading on the ammeter. The ammeter reading should be within the limits specified in the performance test record card under Voltage Priority Programming Accuracy + 1mA Current limit.	
4. Program the output current limit to 0.5A. Measure the output current.	"CURR:LIM 0.5, (@1) " "MEAS:CURR? (@1) "

- | | | |
|-----|---|--|
| 5. | Set the ammeter to the 1A range, and record the output current reading on the ammeter. The ammeter reading should be within the limits specified in the test record card under Voltage Priority Programming Accuracy + 0.5A Current limit. The <i>difference</i> between the ammeter reading and the measurement query result should be within the limits specified under Readback Accuracy + 0.5A current. | |
| 6. | Turn off the output and connect a 1k ohm resistor in series with the ammeter across the output as shown in Figure B-1c. You do not need a shorting switch. | "OUTP OFF, (@1) " |
| 7. | Turn on the output and program the 15mA current readback range. Measure the output current. | "OUTP ON, (@1) "
"SENS:CURR:RANG 0.015, (@1) "
"MEAS:CURR? (@1) " |
| 8. | Set the ammeter to the 10mA range, and record the output current reading on the ammeter. The <i>difference</i> between the ammeter reading and the measurement query result should be within the limits specified Readback Accuracy +15mA Current Limit. | |
| 9. | Turn off the output and connect a 20k ohm resistor in series with the ammeter across the output as shown in Figure B-1c. You do not need a shorting switch. | "OUTP OFF, (@1) " |
| 10. | Turn on the output and program the 0.5mA current readback range. Measure the output current. | "OUTP ON, (@1) "
"SENS:CURR:RANG 0.0005, (@1) "
"MEAS:CURR? (@1) " |
| 11. | Set the ammeter to the 1mA range, and record the output current reading on the ammeter. The <i>difference</i> between the ammeter reading and the measurement query result should be within the limits specified Readback Accuracy +0.5mA Current Limit. | |

Negative Current Limit (-CL)

- | Action | Program Commands |
|--|---|
| 1. Reset the dc source and connect an ammeter directly across the HI and LO terminals as shown in Figure B-1a.
(*RST resets the dc source to its default settings with the output off.) | "*RST" |
| 2. Turn on the dc source and program the output voltage to -10 volts.
(The default output current limit is set to 1mA.) | "OUTP ON, (@1) "
"VOLT -10, (@1) " |
| 3. Set the ammeter to the 1mA range, and record the output current reading on the ammeter. The ammeter reading should be within the limits specified in the performance test record card under Voltage Priority Programming Accuracy -1mA Current limit. | |
| 4. Program the output current limit to 0.5A. Measure the output current. | "CURR:LIM 0.5, (@1) "
"MEAS:CURR? (@1) " |
| 5. Set the ammeter to the 1A range, and record the output current reading on the ammeter. The ammeter reading should be within the limits specified in the test record card under Voltage Priority Programming Accuracy -0.5A Current limit. The <i>difference</i> between the ammeter reading and the measurement query result should be within the limits specified under Readback Accuracy -0.5A current. | |
| 6. Turn off the output and connect a 1k ohm resistor in series with the ammeter across the output as shown in Figure B-1c. You do not need a shorting switch. | "OUTP OFF, (@1) " |

B - Performance and Calibration Procedures

7. Turn on the output and program the **15mA** current readback range. Measure the output current.
"OUTP ON, (@1)"
"SENS:CURR:RANG 0.015, (@1)"
"MEAS:CURR? (@1)"
8. Set the ammeter to the 10mA range, and record the output current reading on the ammeter. The *difference* between the ammeter reading and the measurement query result should be within the limits specified Readback Accuracy –15mA Current Limit.
9. Turn off the output and connect a 20k ohm resistor in series with the ammeter across the output as shown in Figure B-1c. You do not need a shorting switch.
"OUTP OFF, (@1)"
10. Turn on the output and program the **0.5mA** current readback range. Measure the output current.
"OUTP ON, (@1)"
"SENS:CURR:RANG 0.0005, (@1)"
"MEAS:CURR? (@1)"
11. Set the ammeter to the 1mA range, and record the output current reading on the ammeter. The *difference* between the ammeter reading and the measurement query result should be within the limits specified Readback Accuracy –0.5mA Current Limit.

Current Priority Tests

Current Programming and Readback Accuracy

NOTE: The voltage limits in Current Priority Mode are not programmable.

Action	Program Commands
1. Reset the dc source and connect an ammeter directly across the HI and LO terminals as shown in Figure B-1a. (*RST resets the dc source to its default settings with the output off.)	"*RST"
2. Turn on the dc source and program the Current Priority mode. (The default output current is set to 0A.)	"OUTP ON, (@1)" "SOUR:FUNC:MODE CURR, (@1)"
3. Set the ammeter to the 1 μ A range, and record the output current reading on the ammeter. The reading should be within the limits specified in the performance test record card under Current Priority Programming Accuracy @ 0A.	
4. Program the output current to 0.5mA. Measure the output current.	"CURR 0.0005, (@1)"
5. Set the ammeter to the 1mA range, and record the output current reading on the ammeter. The reading should be within the limits specified in the performance test record card under Current Priority Programming Accuracy @ 0.5mA.	
6. Program the output current to –0.5mA. Measure the output current.	"CURR -0.0005, (@1)"
7. Set the ammeter to the 1mA range, and record the output current reading on the ammeter. The reading should be within the limits specified in the performance test record card under Current Priority Programming Accuracy @ –0.5mA.	

Load Effect Tests

The following tests verify the dc regulation of the output voltage and current. To insure that the values read are truly dc and not affected by output ripple, several dc measurements should be made and the average of these readings calculated. An example of how to do this is given below using an Agilent 3458A System Voltmeter programmed from the front panel. Set up the voltmeter and execute the "Average Reading" program follows:

- a. Program 10 power line cycles per sample by pressing NPLC 1 0 ENTER .
- b. Program 100 samples per trigger by pressing (N Rdgs/Trig) 1 0 0 ENTER .
- c. Set up voltmeter to take measurements in the statistical mode as follows:
Press Shift key, f0, Shift key, N
Press ^ (up arrow) until MATH function is selected, then press >.
Press ^ (up arrow) until STAT function is selected then press (ENTER).
- d. Set up voltmeter to read the average of the measurements as follows:
Press Shift key, f1, Shift key, N.
Press down arrow until RMATH function is selected, then press >.
Press ^ (up arrow) until MEAN function is selected, then press ENTER.
- e. Execute the program by pressing f0, ENTER, TRIG, ENTER
- f. Wait for 100 readings and then read the average measurement by pressing f1, ENTER.

To repeat the measurement, perform steps (e) and (f).

Voltage Priority, Constant Voltage Load Effect

This test measures the change in output voltage resulting from a change in output current from about zero amps to about 0.5 amps.

Action	Program Commands
1. Turn off the dc source and connect the output as shown in Figure B-1b with the DMM across the HI and LO sense terminals. Connect the 20 ohm load resistor and switch across the HI and LO output terminals.	"*RST"
2. Start with the load disconnected (switch open). Turn on the dc source, program the output voltage to the full-scale value (10.0V), and the current limit to the maximum value (0.5125A).	"OUTP ON, (@1) " "VOLT 10, (@1) " "CURR:LIM 0.5125, (@1) "
3. Set the DVM to the 10V range, and record the output voltage reading. (zero-load value)	
4. Connect the 20 ohm load resistor across the output (close the switch). Keep the DVM connected.	
6. Read back the N3280A status to be sure that it's in the CV mode. This query should return a Bit value of "1" for CV mode. If it is not in CV mode, use a slightly higher value resistor so that the output current drops slightly.	"STAT:OPER:COND? (@1) "
7. Record the output voltage reading on the DVM. (full-load value) The difference between these two DVM readings is the Load Effect voltage and should be within the limits listed in the performance test record card under Voltage Priority Load Effect Voltage.	

B - Performance and Calibration Procedures

Voltage Priority, +Current Limit Load Effect

This test measures the change in output current resulting from a change in output voltage from about zero volts to about 10 volts.

Action	Program Commands
1. Turn off the dc source and connect the output as shown in Figure B-1c with an ammeter in series with a 20 ohm load resistor across the Hi and Lo output terminals. Also connect a shorting switch across the resistor.	"*RST"
2. Start with a short across the output (switch closed). Turn on the dc source and program the output voltage to the maximum positive value (+10.25V), and the current limit to 0.5A.	"OUTP ON, (@1) " "VOLT 10.25, (@1) " "CURR:LIM 0.5, (@1) "
3. Set the ammeter to the 1A range, and record the output current reading on the ammeter. (shorted-output value)	
4. Remove the short (open the switch) from the output of the dc source.	
5. Read back the N3280A status to be sure that it's in the +CL mode. This query should return a Bit value of "2" for +CL mode. If it is not in +CL mode, decrease the current limit setting slightly. If you adjusted the current limit, close the switch and go back to step 3.	"STAT:OPER:COND? (@1) "
6. Record the output current reading on the ammeter. (full-load current value) The difference between the two current readings is the Load effect current and should be within the limits listed in the performance test record card under Voltage Priority Source Effect +Current.	

Voltage Priority, -Current Limit Load Effect Test

This test measures the change in output current resulting from a change in output voltage from about zero volts to about -10 volts.

Action	Program Commands
1. Turn off the dc source and connect the output as shown in Figure B-1c with an ammeter in series with a 20 ohm load resistor across the Hi and Lo output terminals. Also connect a shorting switch across the resistor.	"*RST"
2. Start with a short across the output (switch closed). Turn on the dc source and program the output voltage to the maximum negative value (-10.25V), and the current limit to 0.5A.	"OUTP ON, (@1) " "VOLT -10.25, (@1) " "CURR:LIM 0.5, (@1) "
3. Set the ammeter to the 1A range, and record the output current reading on the ammeter. (shorted-output value)	
4. Remove the short (open the switch) from the output of the dc source.	
5. Read back the N3280A status to be sure that it's in the -CL mode. This query should return a Bit value of "4" for -CL mode. If it is not in -CL mode, decrease the current limit setting slightly. If you adjusted the current limit, close the switch and go back to step 3.	"STAT:OPER:COND? (@1) "
6. Record the output current reading on the ammeter. (full-load current value) The difference between the two current readings is the Load effect current and should be within the limits listed in the performance test record card under Voltage Priority Source Effect -Current.	

Current Priority Constant Current Test

This test measures the change in output current resulting from a change in output voltage from about zero volts to the maximum output voltage.

NOTE: The voltage limits in Current Priority Mode are not programmable.

Action	Program Commands
1. Turn off the dc source and connect the output as shown in Figure B-1c with an ammeter in series with a 16k ohm load resistor across the Hi and Lo output terminals. Also connect a shorting switch across the resistor.	"*RST"
2. Start with a short across the output (switch closed). Turn on the dc source and program the Current Priority mode. Program the current to the maximum value (0.5mA).	"OUTP ON, (@1) " "SOUR:FUNC:MODE CURR, (@1) " "CURR 0.0005, (@1) "
3. Set the ammeter to the 1A range, and record the output current reading on the ammeter (shorted-output value).	
5. Remove the short from the output (open the switch).	
6. Read back the N3280A status to be sure that it's in the CC mode. This query should return a Bit value of "8" for CC mode.	"STAT:OPER:COND? (@1) "
7. Record the output current reading on the ammeter (full-load current value).	
The difference between the two current readings is the Load Effect current and should be within the limits listed in the performance test record card for the appropriate model under Current Priority Load Effect Current.	

Source Effect Tests

These tests measure the change in output voltage or current that results from a change in ac line voltage from the minimum to maximum value within the line voltage specifications. The tests should all be done at 60Hz line frequency.

Voltage Priority, Constant Voltage Source Effect

Action	Program Commands
1. Connect the ac input of the dc source to a variable voltage transformer (or ac source). Set the transformer to nominal line voltage. Connect the output as shown in Figure B-1b with a 20 ohm resistor or an electronic load across the output terminals and a DVM across the Hi and Lo sense terminals.	
2. Turn on the dc source, program the output voltage to the full-scale value (10.0V), and the current limit to the maximum value (0.5125A).	"OUTP ON, (@1) " "VOLT 10, (@1) " "CURR:LIM 0.5125, (@1) "
3. If you are using an electronic load, adjust it for the full-scale output current, 0.5A.	

B - Performance and Calibration Procedures

4. Read back the N3280A status to be sure that it's in the **CV** mode. This query should return a Bit value of "1" for **CV** mode.
If it is not in **CV** mode, adjust the load or the output voltage slightly until the unit goes into **CV** mode.
"STAT:OPER:COND? (@1)"
5. Adjust the transformer to the lowest rated line voltage.
(e.g., 104 Vac for a 120 Vac nominal line voltage input).
Set the DVM to the 10V range, and record the output voltage reading on the DVM. (low-line value)
6. Adjust the transformer to the highest rated line voltage.
(e.g., 127 Vac for 120 Vac nominal line voltage input).
Record the output voltage reading on the DVM. (high-line value)
7. The difference between the low-line and the high-line value is the source effect voltage and should be within the limits listed in the performance test record card under Voltage Priority Source Effect Voltage.

Voltage Priority, +Current Limit Source Effect

Action

1. Connect the ac input of the dc source to a variable voltage transformer (or ac source). Set the transformer to nominal line voltage.
Connect the output as shown in Figure B-1a with an ammeter directly across the Hi and Lo output terminals.
2. Turn on the dc source and program the output voltage to the maximum positive value (+10.25V), and the current limit to 0.5A.
3. Read back the N3280A status to be sure that it's in the **+CL** mode. This query should return a Bit value of "2" for **+CL** mode.
4. Adjust the transformer to the lowest rated line voltage
(e.g., 104 Vac for a 120 Vac nominal line voltage input).
Set the ammeter to the 1A range, and record the current reading on the ammeter. (low-line value)
5. Adjust the transformer to the highest rated line voltage
(e.g., 127 Vac for 120 Vac nominal line voltage input).
Record the current reading on the ammeter. (high-line value)
6. The difference between the low-line and the high-line values is the source effect voltage and should be within the limits listed in the performance test record card under Voltage Priority Source Effect +Current Limit.

Program Commands

```
"OUTP ON, (@1)"  
"VOLT 10.25, (@1)"  
"CURR:LIM 0.5, (@1)"  
"STAT:OPER:COND? (@1)"
```

Voltage Priority, -Current Limit Source Effect

Action

1. Connect the ac input of the dc source to a variable voltage transformer (or ac source). Set the transformer to nominal line voltage.
Connect the output as shown in Figure B-1a with an ammeter directly across the Hi and Lo output terminals.
2. Turn on the dc source and program the output voltage to the maximum negative value (-10.25V), and the current limit to 0.5A.

Program Commands

```
"OUTP ON, (@1)"  
"VOLT -10.25, (@1)"  
"CURR:LIM 0.5, (@1)"
```

3. Read back the N3280A status to be sure that it's in the **-CL** mode. This query should return a Bit value of "4" for **-CL** mode. `"STAT:OPER:COND? (@1)"`
4. Adjust the transformer to the lowest rated line voltage (e.g., 104 Vac for a 120 Vac nominal line voltage input). Set the ammeter to the 1A range, and record the current reading on the ammeter. (low-line value)
5. Adjust the transformer to the highest rated line voltage (e.g., 127 Vac for 120 Vac nominal line voltage input). Record the current reading on the ammeter. (high-line value)
6. The difference between the low-line and the high-line values is the source effect voltage and should be within the limits listed in the performance test record card under Voltage Priority Source Effect -Current Limit.

Current Priority, Constant Current Source Effect

NOTE: The voltage limits in Current Priority Mode are not programmable.

Action	Program Commands
1. Connect the ac input of the dc source to a variable voltage transformer (or ac source). Set the transformer to nominal line voltage. Connect the output as shown in Figure B-1a with an ammeter directly across the Hi and Lo output terminals.	
2. Turn on the dc source and program the Current Priority mode. Program the current to 0.5mA.	<code>"OUTP ON, (@1)"</code> <code>"SOUR:FUNC:MODE CURR, (@1)"</code> <code>"CURR 0.0005, (@1)"</code>
3. Read back the N3280A status to be sure that it's in the CC mode. This query should return a Bit value of "8" for CC mode.	<code>"STAT:OPER:COND? (@1)"</code>
4. Adjust the transformer to the lowest rated line voltage (e.g., 104 Vac for a 120 Vac nominal line voltage input). Set the ammeter to the 1mA range, and record the current reading on the ammeter. (low-line value)	
5. Adjust the transformer to the highest rated line voltage (e.g., 127 Vac for 120 Vac nominal line voltage input). Record the current reading on the ammeter. (high-line value)	
6. The difference between the low-line and the high-line values is the source effect current and should be within the limits listed in the performance test record card under Current Priority Source Effect Current.	

Ripple and Noise Tests

Voltage Priority Ripple and Noise

Periodic and random deviations (PARD) in the output (ripple and noise) combine to produce a residual ac voltage superimposed on the dc output voltage. PARD is specified as the rms or peak-to-peak output voltage in the frequency range specified in Appendix A.

Action	Program Commands
1. Turn off the dc source and connect the output as shown in Figure B-1d to an oscilloscope (ac coupled) between the HI and LO terminals. (You can use the Model URE3 P-P Voltmeter in place of the scope.) Remember to include a 50 ohm series resistor at the dc source end of the cable. Also connect a 20 ohm load resistor across the HI and LO terminals. Set the scope's bandwidth limit to 20 MHz. Use shielded cable < 1 meter in length if possible. Attach the cable as close to the dc source connector as possible.	"*RST"
2. Turn on the dc source and program the Voltage Priority mode (this is the default mode). Program the output voltage to the full-scale value (10.0V), and the current limit to the maximum value (0.5125A).	"OUTP ON, (@1)" "VOLT 10, (@1)" "CURR:LIM 0.5125, (@1)"
3. Note that the waveform on the oscilloscope should not exceed the peak-to-peak limit in the performance test record card under Voltage Priority PARD Voltage (peak to peak).	
4. Disconnect the oscilloscope and connect an ac rms voltmeter in its place. The rms voltage reading should be within the rms limit in the performance test record card for the appropriate model under Voltage Priority PARD Voltage (rms).	
5. Program the output voltage to the maximum positive value (+10.25V), and the current limit to 0.45A.	"VOLT 10.25, (@1)" "CURR:LIM 0.45, (@1)"
6. Read back the N3280A status to be sure that it's in the +CL mode. This query should return a Bit value of "2" for +CL mode. If it is not in +CL mode, decrease the current limit setting slightly.	"STAT:OPER:COND? (@1)"
7. Divide the voltage reading of the ac rms voltmeter by 20 (the value of the load resistor). The result should be within the limit in the performance test record card under Voltage Priority PARD Current Limit.	
8. Program the output voltage to the maximum negative value (-10.25V).	"VOLT -10, (@1)"
9. Read back the N3280A status to be sure that it's in the -CL mode. This query should return a Bit value of "4" for -CL mode. If it is not in -CL mode, decrease the current limit setting slightly.	"STAT:OPER:COND? (@1)"
10. Divide the voltage reading of the ac rms voltmeter by 20 (the value of the load resistor). The result should be within the limit in the performance test record card under Voltage Priority PARD Current Limit.	

Current Priority Ripple and Noise

Periodic and random deviations (PARD) in the output combine to produce a residual ac current, as well as an ac voltage superimposed on the dc output. PARD is specified as the rms output current in a frequency range specified in Appendix A.

NOTE: The voltage limits in Current Priority Mode are not programmable.

Action	Program Commands
1. Turn off the dc source and connect the output as shown in Figure B-1d to an ac rms voltmeter. Remember to include a 50 ohm series resistor at the dc source end of the cable. Also connect a 16k ohm load resistor across the HI and LO terminals.	
2. Turn on the dc source and program the Current Priority mode. Program the current to the maximum value (0.5mA).	"OUTP ON, (@1) " "SOUR:FUNC:MODE CURR, (@1) " "CURR 0.0005, (@1) "
3. Read back the N3280A status to be sure that it's in the CC mode. This query should return a Bit value of "8" for CC mode.	"STAT:OPER:COND? (@1) "
4. Divide the voltage reading ac rms voltmeter by 16k (the value of the load resistor). The result should be within the limit in the performance test record card under Current Priority PARD Current.	

Transient Response Tests

Voltage Priority, Transient Recovery Time

This test measures the time for the output voltage to recover to within the specified value following a 50% change in the load current using an RC network of a 10 μ F capacitor and 0.2 ohm resistor across the output. The test must be performed in all three bandwidths: 10kHz, 20kHz, and 30kHz.

Action	Program Commands
1. Turn off the dc source and connect the output as in Figure B-1e with the oscilloscope across the HI and LO sense terminals. Remember to connect the RC network (10 μ F & 0.2 ohm).	"OUTP OFF, (@1) "
2. Turn on the dc source and program the Voltage Priority mode (this is the default mode). Program the output voltage to the full-scale value (10.0V), the current to the maximum value (0.5A), and the bandwidth to 10kHz.	"OUTP ON, (@1) " "SOUR:FUNC:MODE VOLT, (@1) " "VOLT 10, (@1) " "CURR:LIM 0.5, (@1) " "VOLT:ALC:BWID 10000, (@1) "
3. Program the Electronic Load as follows: Input current = 0.25A Transient current level = 0.5A Transient frequency = 2kHz Current slew rate = 0.167A/ μ s Transient duty cycle = 50% Turn the transient generator on.	
4. Adjust the oscilloscope for a waveform similar to that in Figure B-2. The output voltage should return to within ± 40 mV in less than 60 μ s, 45 μ s, or 35 μ s following a 0.25A to 0.5A load change. Check both loading and unloading transients by triggering on the positive and negative slope. Record the voltage at time "t" in the performance test record card under Voltage Priority Transient Response Voltage.	
5. Repeat steps 2 through 4 for the 20kHz and the 30kHz bandwidths.	"VOLT:ALC:BWID 20000, (@1) " "VOLT:ALC:BWID 30000, (@1) "

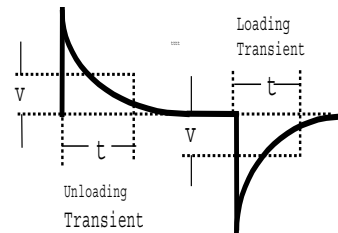

B - Performance and Calibration Procedures

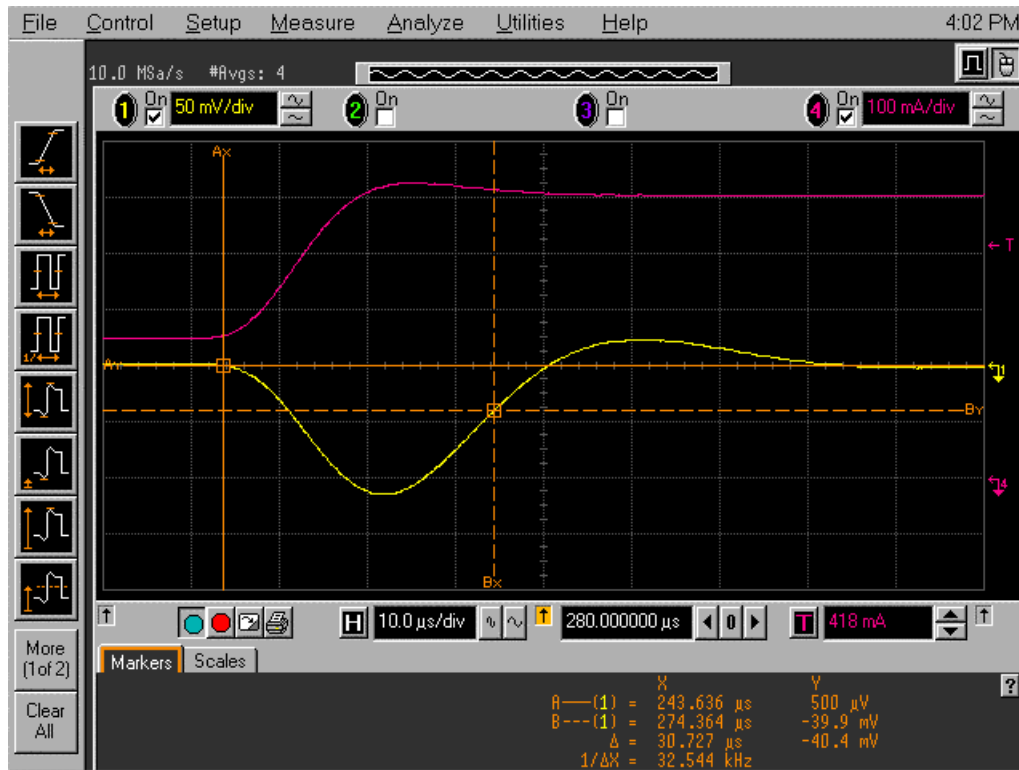

Figure B-2. Transient Waveform Voltage Priority

Current Priority Transient Recovery Time

This test measures the time for the output current to recover to within the specified value following a $\pm 1V$ change in the output voltage. The test setup uses a $0.47\mu F$ capacitor across the output of the generator to form an approximate $25\mu s$ time constant with the $50\ \Omega$ output of the function generator.

NOTE: Turn off the output of the dc source before connecting the function generator.

Action	Program Commands
1. Turn off the dc source and connect the output as in Figure B-1f with the function generator across the HI and LO terminals. Remember to connect the capacitor ($0.47\mu F$) close to the function generator. Keep all leads as short as possible.	"OUTP OFF, (@1) "
2. Turn on the dc source and program the Current Priority mode. Program the current to zero amps.	"OUTP ON, (@1) " "SOUR:FUNC:MODE CURR, (@1) " "CURR 0, (@1) "
3. Program the Function Generator as follows: Frequency = 400Hz to 1kHz Duty cycle = 50% Wave shape = $\pm 1V$ square wave.	
Set the Tektronics current probe to measure current at 2mA/div.	
4. Adjust the oscilloscope for a waveform similar to that in Figure B. The output current should return to within $\pm 1mA$ in less than $90\mu s$. Check both loading and unloading transients by triggering on the positive and negative slope. Record the voltage at time "t" in the performance test record card under Current Priority Transient Response Current.	

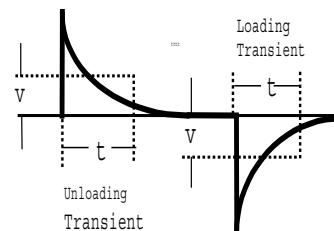

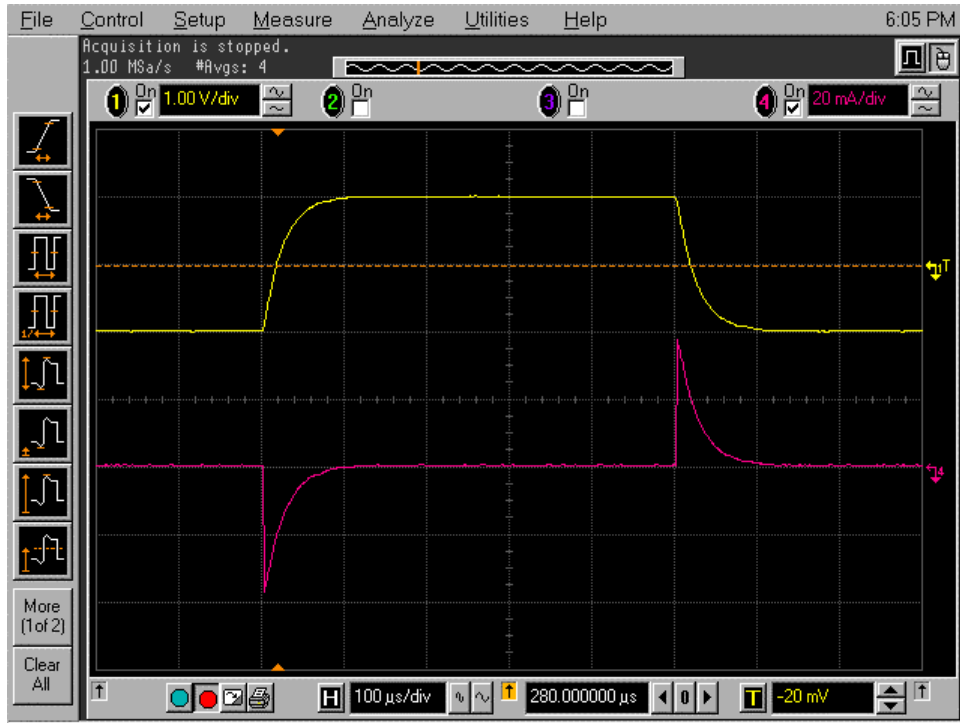

Figure B-3. Transient Waveform Current Priority

Performance Test Equipment Form

<p>Test Facility: _____</p> <p>_____</p> <p>_____</p> <p>_____</p> <p>Model _____</p> <p>Serial No. _____</p> <p>Options _____</p> <p>Firmware Revision _____</p> <p>Special Notes:</p> <p>Test Equipment Used:</p> <table border="1" style="width: 100%; border-collapse: collapse;"> <thead> <tr> <th style="width: 30%;">Description</th> <th style="width: 20%;">Model No.</th> <th style="width: 20%;">Trace No.</th> <th style="width: 30%;">Cal. Due Date</th> </tr> </thead> <tbody> <tr> <td>AC Source</td> <td>_____</td> <td>_____</td> <td>_____</td> </tr> <tr> <td>DC Voltmeter</td> <td>_____</td> <td>_____</td> <td>_____</td> </tr> <tr> <td>RMS Voltmeter</td> <td>_____</td> <td>_____</td> <td>_____</td> </tr> <tr> <td>Oscilloscope</td> <td>_____</td> <td>_____</td> <td>_____</td> </tr> <tr> <td>Electronic Load</td> <td>_____</td> <td>_____</td> <td>_____</td> </tr> <tr> <td>_____</td> <td>_____</td> <td>_____</td> <td>_____</td> </tr> </tbody> </table>	Description	Model No.	Trace No.	Cal. Due Date	AC Source	_____	_____	_____	DC Voltmeter	_____	_____	_____	RMS Voltmeter	_____	_____	_____	Oscilloscope	_____	_____	_____	Electronic Load	_____	_____	_____	_____	_____	_____	_____	<p>Report Number _____</p> <p>Date _____</p> <p>Customer _____</p> <p>Tested By _____</p> <p>Ambient Temperature (C) _____</p> <p>Relative Humidity (%) _____</p> <p>Nominal Line Frequency _____</p>
Description	Model No.	Trace No.	Cal. Due Date																										
AC Source	_____	_____	_____																										
DC Voltmeter	_____	_____	_____																										
RMS Voltmeter	_____	_____	_____																										
Oscilloscope	_____	_____	_____																										
Electronic Load	_____	_____	_____																										
_____	_____	_____	_____																										

Performance Test Record Form

Model Agilent N3280A - Output 1	Report No	Date	
Test Description	Minimum Specification	Results	Maximum Specification
VOLTAGE PRIORITY TESTS			
Programming Accuracy (DMM readings)			
Voltage (0V)	- 2mV	_____	+ 2mV
Voltage (+10V)	9.988 V	_____	10.012 V
Voltage (-10V)	- 9.988 V	_____	- 10.012 V
+ 1mA Current limit	0.949mA	_____	1.051mA
+ 0.5A Current limit	0.49945 A	_____	0.50055 A
- 1mA Current limit	-0.949mA	_____	- 1.051mA
- 0.5A Current limit	- 0.49945 A	_____	- 0.50055 A
Readback Accuracy (MEAS? readings)			
Voltage (0V)	- 2mV	_____	+ 2mV
Voltage (+10V)	Vout - 12mV	_____	Vout + 12mV
Voltage (-10V)	Vout - 12mV	_____	Vout + 12mV
+ 0.5A range current	Iout - 0.7mA	_____	Iout + 0.7mA
- 0.5A range current	Iout - 0.7mA	_____	Iout + 0.7mA
+ 15mA range current	Iout - 15μA	_____	Iout + 15μA
- 15mA range current	Iout - 15μA	_____	Iout + 15μA
+ 0.5mA range current	Iout - 0.7μA	_____	Iout + 0.7μA
- 0.5mA range current	Iout - 0.7μA	_____	Iout + 0.7μA
Load Effect			
Voltage	- 400μV	_____	+ 400μV
+ Current limit	- 30μA	_____	+ 30μA
- Current limit	- 30μA	_____	+ 30μA
Source Effect			
Voltage	- 200μV	_____	- 200μV
+ Current limit	- 10μA	_____	- 10μA
- Current limit	- 10μA	_____	- 10μA
PARD (Ripple and Noise)			
Voltage (rms)		_____	380μV
Voltage (peak-to-peak)		_____	4mV
±Current limit (rms)		_____	40μA
Transient Response Time	Low(10kHz):	_____	60μs
	Med (20kHz):	_____	45μs
	High (30kHz):	_____	35μs
CURRENT PRIORITY TESTS			
Programming Accuracy (DMM readings)			
Current (0A)	- 1μA	_____	+ 1μA
Current (0.5mA)	0.0004985 A	_____	0.0005015 A
Current (-0.5mA)	- 0.0004985 A	_____	- 0.0005015 A
Load Effect			
Current	- 25nA	_____	+ 25nA
Source Effect			
Current	- 10nA	_____	+ 10nA
PARD (Ripple and Noise)			
Current (rms)		_____	1.5μA
Transient Response Time		_____	90μs

Performing the Calibration Procedure

You can only calibrate the dc source by using SCPI commands within your controller programming statements. The SCPI calibration commands are explained in chapter 8. Calibration error messages that can occur during GPIB calibration are shown in table B-3.

Table B-1 lists the equipment required for calibration. Figure B-1 shows the test setup. Calibrating the N3280A power supply requires an HP 3458 DMM or something with equivalent voltage and current measurement accuracy. For all calibration steps, connect the high sense terminal to the high output, and the low sense terminal to the low output. A general outline of the calibration procedure is as follows:

1. Enable calibration by sending the CAL:STATE ON <password> command. The password argument is a number which is set at the factory to the model number of the power supply, and can be changed by the user.
2. Calibrate one or more subsystems using the commands given in the following sections. Calibrate only one of the 4 output channels at a time. The calibration commands accept only a single channel number for the channel list arguments.
3. Whenever a subsystem's calibration is changed, all subsystems listed below it must also be re-calibrated. However, voltage and current subsystems are independent (changing the calibration of one does not require re-calibration of the other).
4. As each subsystem's procedure is completed, the instrument calculates new calibration constants and begins using them. These constants are not saved in nonvolatile memory until the CAL:SAVE command is given. CAL:SAVE can be given after each subsystem is done or given once after all subsystems are done.
5. Disable calibration by sending CAL:STATE OFF. Any subsystems that were calibrated with a subsequent CAL:SAVE revert to their previous calibration constants. Note that *RST also sets the calibration state to OFF.

Enable Calibration Mode

Action	Program Commands
1. Reset the unit.	"*RST"
2. Enable calibration mode. (If the password is incorrect, an error occurs.)	"CAL:STAT ON, 0"

Voltage Priority Mode Programming and Measurement Calibration

Action	Program Commands
1. Jumper the High sense terminal to the High output terminal. Jumper the Low sense terminal to the Low output terminal. Connect the voltage input of the 3458A multimeter directly to output 1.	
2. Select voltage calibration for output 1.	"CAL:VOLT (@1)"
3. Select the first calibration point. *OPC? prevents processing of all subsequent commands to ensure that the output is stable.	"CAL:LEV P1;*OPC?"
4. Set the 3458A multimeter to the 10V range, measure the output voltage, and enter the data into the dc source.	"CAL:DATA <value>"
5. Select the second calibration point. *OPC? prevents processing of all subsequent commands to ensure that the output is stable.	"CAL:LEV P2;*OPC?"
6. Measure the output voltage and enter the data into the dc source.	"CAL:DATA <value>"

B - Performance and Calibration Procedures

Negative Current Limit Calibration

Action	Program Commands
1. Jumper the High sense terminal to the High output terminal. Jumper the Low sense terminal to the Low output terminal. Connect the current input of the 3458A multimeter directly to output 1.	
2. Select negative current limit calibration for output 1.	"CAL:CURR:LIM:NEG (@1)"
3. Select the first calibration point. *OPC? prevents processing of all subsequent commands to ensure that the output is stable.	"CAL:LEV P1;*OPC?"
4. Set the 3458A multimeter to the 1A range, measure the output current, and enter the data into the dc source.	"CAL:DATA <value>"
5. Select the second calibration point. *OPC? prevents processing of all subsequent commands to ensure that the output is stable.	"CAL:LEV P2;*OPC?"
6. Measure the output current and enter the data into the dc source.	"CAL:DATA <value>"

Positive Current Limit Calibration

Action	Program Commands
1. Jumper the High sense terminal to the High output terminal. Jumper the Low sense terminal to the Low output terminal. Connect the current input of the 3458A multimeter directly to output 1.	
2. Select positive current limit calibration for output 1.	"CAL:CURR:LIM:POS (@1)"
3. Select the first calibration point. *OPC? prevents processing of all subsequent commands to ensure that the output is stable.	"CAL:LEV P1;*OPC?"
4. Set the 3458A multimeter to the 1A range, measure the output current, and enter the data into the dc source.	"CAL:DATA <value>"
5. Select the second calibration point. *OPC? prevents processing of all subsequent commands to ensure that the output is stable.	"CAL:LEV P2;*OPC?"
6. Measure the output current and enter the data into the dc source.	"CAL:DATA <value>"

0.5A Range Current Measurement Calibration

Action	Program Commands
1. Jumper the High sense terminal to the High output terminal. Jumper the Low sense terminal to the Low output terminal. Connect the current input of the 3458A multimeter directly to output 1.	
2. Select the 0.5A range current measurement calibration for output 1.	"CAL:CURR:MEAS 0.5, (@1)"
3. Select the calibration point. *OPC? prevents processing of all subsequent commands to ensure that the output is stable.	"CAL:LEV P1;*OPC?"
4. Set the 3458A multimeter to the 1A range, measure the output current, and enter the data into the dc source.	"CAL:DATA <value>"

15mA Range Current Measurement Calibration

Action	Program Commands
1. Jumper the High sense terminal to the High output terminal. Jumper the Low sense terminal to the Low output terminal. Connect the current input of the 3458A multimeter directly to output 1.	
2. Select the 15mA range current measurement calibration for output 1.	"CAL:CURR:MEAS 0.015, (@1)"
3. Select the calibration point. *OPC? prevents processing of all subsequent commands to ensure that the output is stable.	"CAL:LEV P1;*OPC?"
4. Set the 3458A multimeter to the 10mA range, measure the output current, and enter the data into the dc source.	"CAL:DATA <value>"

Current Priority Mode Programming and 0.5mA Range Measurement Calibration

Action	Program Commands
1. Jumper the High sense terminal to the High output terminal. Jumper the Low sense terminal to the Low output terminal. Connect the current input of the 3458A multimeter directly to output 1.	
2. Select current calibration for output 1.	"CAL:CURR (@1)"
3. Select the first calibration point. *OPC? prevents processing of all subsequent commands to ensure that the output is stable.	"CAL:LEV P1;*OPC?"
4. Set the 3458A multimeter to the 1mA range, measure the output current, and enter the data into the dc source.	"CAL:DATA <value>"
5. Select the second calibration point. *OPC? prevents processing of all subsequent commands to ensure that the output is stable.	"CAL:LEV P2;*OPC?"
6. Measure the output current and enter the data into the dc source.	"CAL:DATA <value>"

Saving the Calibration Constants

WARNING: Storing calibration constants overwrites the existing ones in non-volatile memory. If you are not sure you want to permanently store the new constants, omit this step. The dc source calibration will then remain unchanged.

Action	Program Commands
1. Save all of the calibration constants.	"CAL:SAVE"
2. Exit Calibration mode. (*RST also exits calibration mode)	"CAL:STAT OFF"

B - Performance and Calibration Procedures

Changing the Calibration Password

The factory default password is 0. You can change the password when the dc source is in calibration mode (which requires you to enter the existing password). Proceed as follows:

Action	Program Commands
1. Reset the unit.	"*RST"
2. Enable calibration mode. (0 is the default password)	"CAL:STAT ON, 0"
3. Enter the new password. You can use any number with up to six digits and an optional decimal point. If you want the calibration function to operate without requiring any password, change the password to 0 (zero).	"CAL:PASS <password>"
4. Save the password.	"CAL:SAVE"
5. Exit Calibration mode. (*RST also exits calibration mode)	"CAL:STAT OFF"

Calibration Error Messages

Errors that can occur during calibration are shown in the following table.

Table B-3. GPIB Calibration Error Messages

Error	Meaning
401	CAL switch prevents calibration (call the factory for details)
402	CAL password is incorrect
403	CAL not enabled
404	Computed readback cal constants are incorrect
405	Computed programming cal constants are incorrect
406	Incorrect sequence of calibration commands

Error Messages

Error Number List

This appendix gives the error numbers and descriptions that are returned by the dc source. Errors are indicated in two ways:

- ◆ The Error or Prot indicators are lit on the front panel.
- ◆ Error numbers and messages are read back with the `SYSTEM:ERRor?` query. `SYSTEM:ERRor?` returns the error number into a variable and returns two parameters: an NR1 and a string.

The following table lists the errors that are associated with SCPI syntax errors and interface problems. It also lists the device dependent errors. Information inside the brackets is not part of the standard error message, but is included for clarification.

When errors occur, the Standard Event Status register records them in bit 2, 3, 4, or 5 as described in the following table:

Table C-1. Error Numbers

Error Number	Error String [Description/Explanation/Examples]
	Command Errors –100 through –199 (sets Standard Event Status Register bit #5)
–100	Command error [generic]
–101	Invalid character
–102	Syntax error [unrecognized command or data type]
–103	Invalid separator
–104	Data type error [e.g., "numeric or string expected, got block data"]
–105	GET not allowed
–108	Parameter not allowed [too many parameters]
–109	Missing parameter [too few parameters]
–112	Program mnemonic too long [maximum 12 characters]
–113	Undefined header [operation not allowed for this device] Check the language setting.
–114	Header suffix out of range [value of numeric suffix is invalid]
–121	Invalid character in number [includes "9" in octal data, etc.]
–123	Numeric overflow [exponent too large; exponent magnitude >32 k]
–124	Too many digits [number too long; more than 255 digits received]
–128	Numeric data not allowed

C – Error Messages

Table C-1. Error Numbers (continued)

-131	Invalid suffix [unrecognized units, or units not appropriate]
-138	Suffix not allowed
-141	Invalid character data [bad character, or unrecognized]
-144	Character data too long
-148	Character data not allowed
-150	String data error
-151	Invalid string data [e.g., END received before close quote]
-158	String data not allowed
-160	Block data error
-161	Invalid block data [e.g., END received before length satisfied]
-168	Block data not allowed
-170	Expression error
-171	Invalid expression
-178	Expression data not allowed
	Execution Errors –200 through –299 (sets Standard Event Status Register bit #4)
-200	Execution error [generic]
-222	Data out of range [e.g., too large for this device]
-223	Too much data [out of memory; block, string, or expression too long]
-224	Illegal parameter value [device-specific]
-225	Out of memory
-270	Macro error
-272	Macro execution error
-273	Illegal macro label
-276	Macro recursion error
-277	Macro redefinition not allowed
	System Errors –300 through –399 (sets Standard Event Status Register bit #3)
-310	System error [generic]
-350	Too many errors [errors beyond 9 lost due to queue overflow]
	Query Errors –400 through –499 (sets Standard Event Status Register bit #2)
-400	Query error [generic]
-410	Query INTERRUPTED [query followed by DAB or GET before response complete]
-420	Query UNTERMINATED [addressed to talk, incomplete programming message received]
-430	Query DEADLOCKED [too many queries in command string]
-440	Query UNTERMINATED [after indefinite response]

Table C-1. Error Numbers (continued)

Selftest Errors 0 through 99 (sets Standard Event Status Register bit #3)	
0	No error
1	Output 1 non-volatile RAM CAL section checksum failed
2	Output 2 non-volatile RAM CAL section checksum failed
3	Output 3 non-volatile RAM CAL section checksum failed
4	Output 4 non-volatile RAM CAL section checksum failed
5	Non-volatile RAM CONFIG section checksum failed
10	RAM selftest
Device-Dependent Errors 100 through 32767 (sets Standard Event Status Register bit #3)	
100	Flash write error
101	Flash erase error
401	CAL switch prevents calibration
402	CAL password is incorrect
403	CAL not enabled
404	Computed readback cal constants are incorrect
405	Computed programming cal constants are incorrect
406	Incorrect sequence of calibration commands
407	CV or CC status is incorrect for this command
601	Too many sweep points
603	CURRENT or VOLTAGE fetch incompatible with last acquisition
604	Measurement overrange
607	Operation not allowed with the present language setting
608	Valid only while the output is disabled
609	No data in acquisition buffer
610	Bad update data
611	Not in update state
900	Bad binary mode call packet checksum
901	Bad binary mode protocol version
902	Bad binary mode function number
903	Bad binary mode channel list
950	Bad binary mode reply packet checksum
951	Bad binary mode transaction ID

Line Voltage Selection

To change the line voltage selection:

1. Remove the line cord.
2. Check if the line voltage displayed in the window must be changed.
3. Open the door using a small flat-bladed screwdriver.
4. Rotate the cylinder so that the correct line voltage appears in the location under the window.
5. Pull the fuse drawer out and check if the fuse is correct for the line voltage that you have selected (see Table 2-1). If the rating is incorrect, replace the fuse with the correct one.

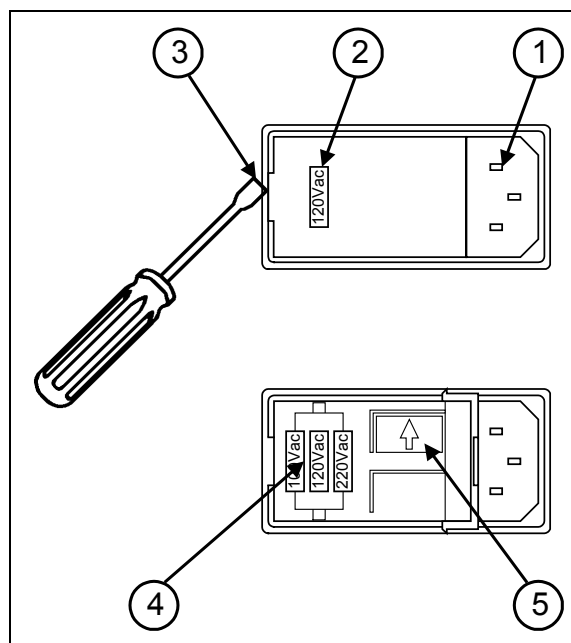

—A—

AARD, 36
ABORT, 72
accessories, 14
address switch, 21
airflow, 20
averaging measurements, 43
AWG ratings, 23

—C—

cables, 14
calibration, 99
 equipment, 83
 error messages, 102
 GPIB, 99
 password, 102
 saving, 101
 setup, 85
calibration commands, 57
 CAL CURR, 57
 LIM, 57
 CAL CURR MEAS, 57
 CAL DATA, 58
 CAL DATE, 58
 CAL LEV, 58
 CAL PASS, 58
 CAL SAVE, 59
 CAL STAT, 59
 CAL VOLT, 59
capabilities, 14
channel
 parameter, 34
 range, 34
character strings, 36
characteristics, 79
checkout procedure, 28
cleaning, 19
coaxial connections, 24
combine commands
 common commands, 33
 from different subsystems, 33
 root specifier, 33
command completion, 36
 external synchronization, 37
 internal synchronization, 37
common command syntax, 53
common commands, 74
 *CLS, 74
 *ESE, 74
 *ESR?, 74
 *IDN?, 75
 *OPC, 75
 *OPT?, 75
 *RST, 76
 *SRE, 76
 *STB?, 76

*TRG, 77
*TST, 77
*WAI, 77
constant voltage tests, 84
controller connections, 25
conventions used in this guide, 32
CRD, 36
current, 40
 measurement range, 45
current measurement range, 61
current monitoring resistor, 85
current priority, 16

—D—

damage, 19
description, 14
determining cause of interrupt, 52
device clear, 37
digital connector, 19
dimensions, 20
disconnect relays, 14

—E—

electronic load, 84
enabling the output, 39
error messages, 29
error numbers, 103
external trigger, 43, 47

—F—

fetch commands, 43, 60
 FETC ARR CURR?, 60
 FETC ARR VOLT?, 60
 FETC CURR?, 60
 FETC VOLT?, 60
front panel
 indicators, 27
 line switch, 27
fuse, 19

—G—

GPIB
 capabilities, 31
GP-IB
 address, 25
 command library for MS DOS, 31
 connections, 25
 controller programming, 31
 IEEE Std for standard codes, 31
 IEEE Std for standard digital interface, 31
 interface, 25
 references, 31
 trigger, 43, 47
GPIB connector, 21

Index

ground, earth, 3
guard connections, 24
guide, user's, 13

—H—

Hanning, 45, 63
header, 35
 long form, 35
 short form, 35
history, 6

—I—

indicator
 Error, 27
 On, 27
 Power, 27
 Prot, 27
indicator
 Active, 27
initialization, 39
initiate commands, 72
 INIT NAME, 72
input
 connections, 21
 power, 14
inspection, 19
internally triggered measurements, 45

—L—

language dictionary, 53
lead resistance, 23
line fuse
 changing, 107
 replacing, 29
line module, 21
line switch, 27
line voltage, 21
 selection, 107
load voltage drops, 23
location, 20

—M—

making measurements, 43
manuals, 19
MAV bit, 51
measure commands, 43, 60
 MEAS ARR CURR?, 61
 MEAS ARR VOLT?, 61
 MEAS CURR?, 61
 MEAS VOLT?, 61
measurement
 overview, 17
 delay, 17
measurement points, 44
measurement samples, 44
measurement trigger
 function, 47
 generating, 47
 initiating, 46

 output delay, 47
 source, 46
measurement trigger system
 model, 46
measurements
 arrays, 45
 Hanning window, 45
 Rectangular window, 45
message terminator, 35
 end or identify, 35
 newline, 35
message unit
 separator, 35
model differences, 14
MSS bit, 51
multipliers, 36

—N—

numerical data formats, 35

—O—

operation status group, 50
optional header
 example, 33
options, 14
oscillation
 protection, 41
output trigger
 generating, 43
output
 compensation, 25
 connections, 22
 connector, 19
output characteristic, 15, 16
output commands, 64
 OUTP, 64
 OUTP OSCP, 64
 OUTP PROT CLE, 64
output connector, 21
output mode, 40
output queue, 51
output trigger
 initiating, 42
 setting, 42
 source, 42
output trigger system
 model, 41
OVP
 circuit, 25
 disable, 25

—P—

PARD, 94
performance
 equipment, 83
 setup, 85
performance test form, 97
post-event triggering, 48
power cord, 19, 21
power line cycles, 44

power-on initialization, 39
 pre-event triggering, 48
 print date, 6
 programming, 85
 programming parameters, 53
 programming status registers, 49

—Q—

queries, 34
 query
 indicator, 35
 questionable status group, 51

—R—

rack mount kit, 14
 rack mounting, 20
 readback accuracy, 86
 rear panel
 connections, 21
 Rectangular, 45, 63
 remote programming, 14
 remote sensing
 with test fixture, 23
 repacking, 19
 returning voltage or current data, 45
 root specifier, 35
 RQS bit, 51

—S—

safety
 class, 13
 summary, 3
 safety warning, 3
 SCPI
 command completion, 36
 command syntax, 53
 command tree, 32
 common commands, 32
 device clear, 37
 header path, 33
 message structure, 34
 message unit, 34
 multiple commands, 33
 program message, 34
 references, 31
 response message, 34
 subsystem commands, 32, 53
 SCPI commands
 at a glance, 54
 selftest errors, 29
 sense commands, 60
 SENS CURR RANG, 61
 SENS FUNC, 62
 SENS SWE NPLC, 62
 SENS SWE OFFS POIN, 62
 SENS SWE POIN, 63
 SENS SWE TINT, 63
 SENS WIND, 63
 sense connections, 22
 servicing operation status, 52

servicing questionable status events, 52
 source commands, 64
 [SOUR] CURR [IMM], 65
 [SOUR] CURR LIM [IMM], 65
 [SOUR] CURR LIM MODE, 65
 [SOUR] CURR LIM TRIG, 65
 [SOUR] CURR MODE, 65
 [SOUR] CURR TRIG, 65
 [SOUR] DEL, 66
 [SOUR] DEL MODE, 66
 [SOUR] FUNC MODE, 66
 [SOUR] VOLT [IMM], 67
 [SOUR] VOLT ALC BWID, 66
 [SOUR] VOLT MODE, 67
 [SOUR] VOLT PROT STAT, 67
 [SOUR] VOLT TRIG, 67
 specifications, 79
 SRD, 36
 stability, 25
 standard event status group, 51
status bit configurations, 50
 status byte register, 51
 status commands, 68
 STAT OPER [EVEN]?, 68
 STAT OPER COND?, 68
 STAT OPER ENAB, 68
 STAT OPER NTR, 69
 STAT OPER PTR, 69
 STAT PRES, 69
 STAT QUES [EVEN]?, 69
 STAT QUES COND?, 70
 STAT QUES ENAB, 70
 STAT QUES NTR, 70
 STAT QUES PTR, 70
subsystem commands syntax, 54
 suffixes, 36
 support rails, 20
 system commands, 71
 SYST ERR?, 71
 SYST VERS?, 71
 system errors, 103

—T—

time interval, 44
 trigger commands, 72
 TRIG [TRAN], 73
 TRIG [TRAN] SOUR, 73
 TRIG ACQ, 72
 TRIG ACQ SOUR, 73
 trigger connector, 25
 trigger offset, 48
 triggering output changes, 41
 types of SCPI commands, 32

—V—

voltage, 39
 protection, 40
 voltage priority, 15
 voltage programming, 86

Index

—W—

waiting for measurement results, 48

warranty, 2

wire

current ratings, 23

Agilent Sales and Support Office

For more information about Agilent Technologies test and measurement products, applications, services, and for a current sales office listing, visit our web site: <http://www.agilent.com/find/tmdir>

You can also contact one of the following centers and ask for a test and measurement sales representative.

United States:

Agilent Technologies
Test and Measurement Call Center
P.O. Box 4026
Englewood, CO 80155-4026
(tel) 1 800 452 4844

Latin America:

Agilent Technologies
Latin American Region Headquarters
5200 Blue Lagoon Drive, Suite #950
Miami, Florida 33126
U.S.A.
(tel) (305) 267 4245
(fax) (305) 267 4286

Canada:

Agilent Technologies Canada Inc.
5150 Spectrum Way
Mississauga, Ontario
L4W 5G1
(tel) 1 877 894 4414

Australia/New Zealand:

Agilent Technologies Australia Pty Ltd
347 Burwood Highway
Forest Hill, Victoria 3131
(tel) 1-800 629 485 (Australia)
(fax) (61 3) 9272 0749
(tel) 0 800 738 378 (New Zealand)
(fax) (64 4) 802 6881

Europe:

Agilent Technologies
Test & Measurement European Marketing Organisation
P.O. Box 999
1180 AZ Amstelveen
The Netherlands
(tel) (31 20) 547 9999

Asia Pacific:

Agilent Technologies
24/F, Cityplaza One, 1111 King's Road,
Taikoo Shing, Hong Kong
tel: (852)-3197-7777
fax: (852)-2506-9284

Japan:

Agilent Technologies Japan Ltd.
Measurement Assistance Center
9-1, Takakura-Cho, Hachioji-Shi,
Tokyo 192-8510, Japan
(tel) (81) 426 56 7832
(fax) (81) 426 56 7840

Technical data is subject to change.